

# T

**T-Series**

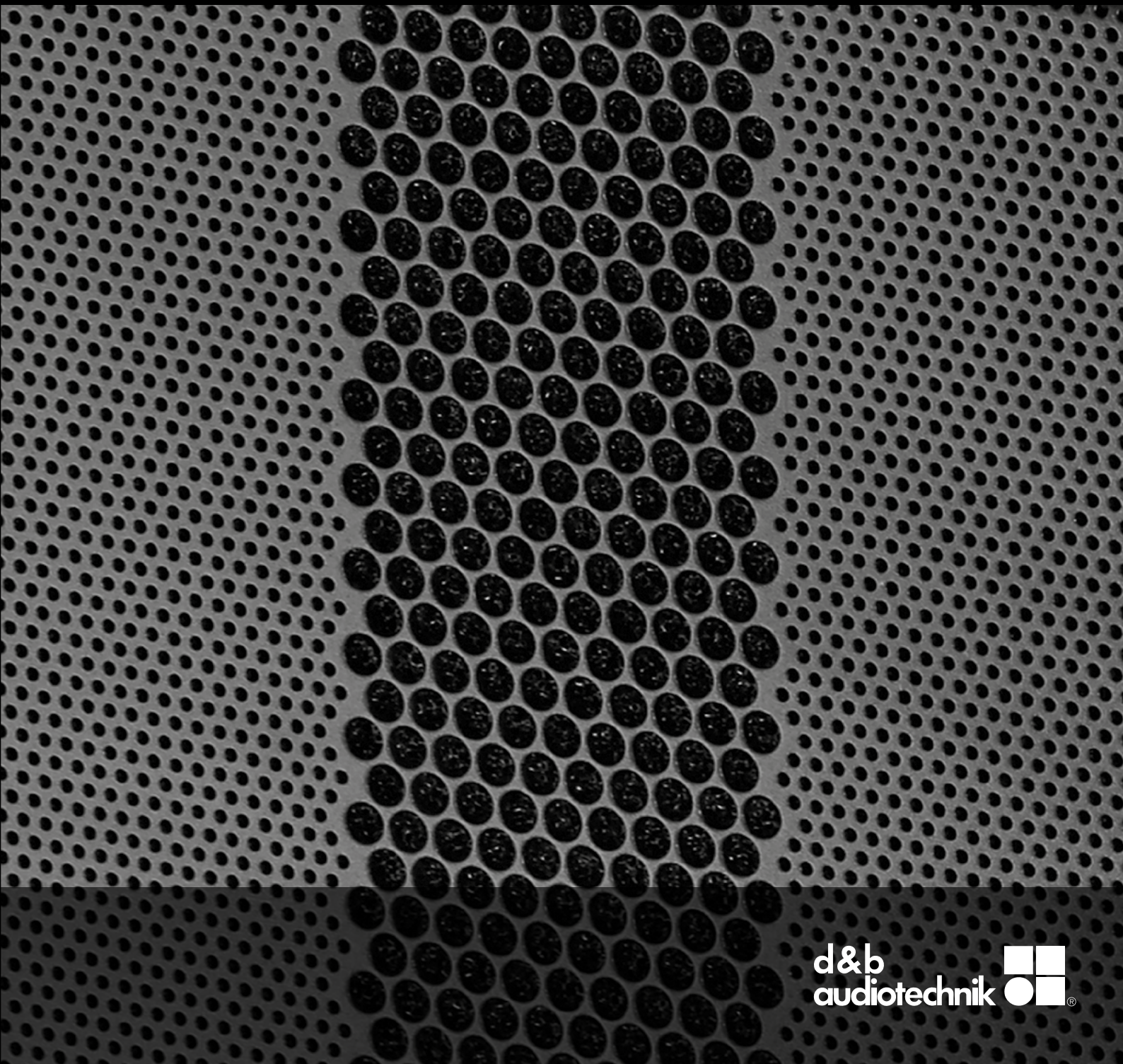

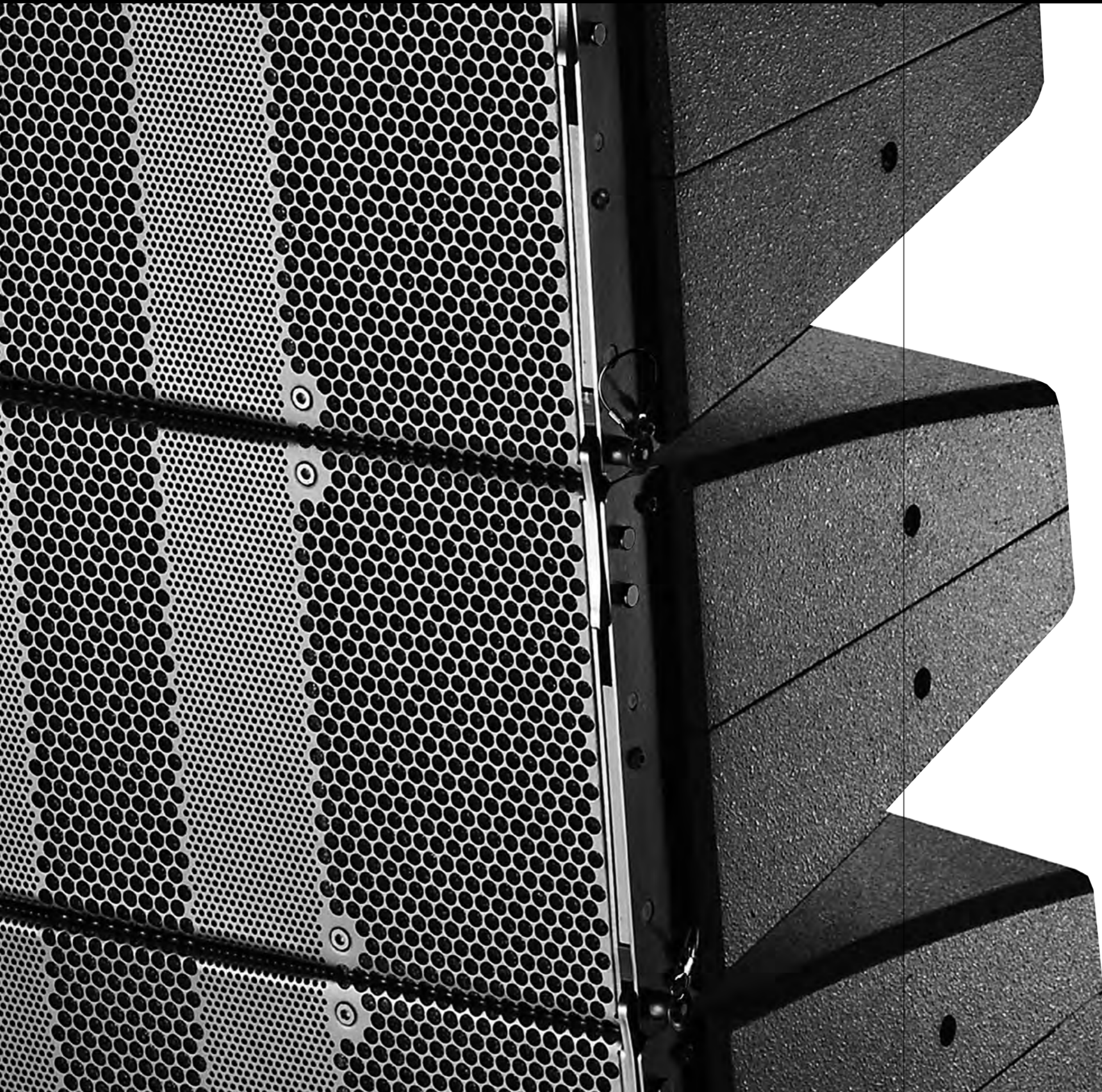

<b>The d&amp;b System reality</b> .....	4
<b>The T-Series</b> .....	6
<b>The T10 loudspeaker</b> .....	10
<b>The T10 electroacoustic concept</b> .....	11
<b>The Ti10L loudspeaker</b> .....	12
<b>The Ti10P loudspeaker</b> .....	13
<b>The T and Ti subwoofers</b> .....	14
<b>The B4 subwoofer</b> .....	15
<b>The T-Series rigging and mounting accessories</b> .....	16
<b>The T-Series rigging and mounting examples</b> .....	17
<b>The Ti Weather Resistant and Special Colour options</b> .....	18
<b>The T-Series cases</b> .....	19
<b>The d&amp;b ArrayCalc simulation software</b> .....	20
<b>The d&amp;b NoizCalc immission modelling software</b> .....	20
<b>The d&amp;b R1 Remote control software</b> .....	21
<b>The d&amp;b amplifiers</b> .....	22
<b>The operation with d&amp;b amplifiers</b> .....	24
<b>The T-Series frequency responses</b> .....	25
<b>The d&amp;b amplifier output modes</b> .....	26
<b>The DS10 Audio network bridge</b> .....	27
<b>The T-Series cables and adapters</b> .....	28
<b>The T-Series configuration examples</b> .....	30
<b>The T-Series product overview</b> .....	34

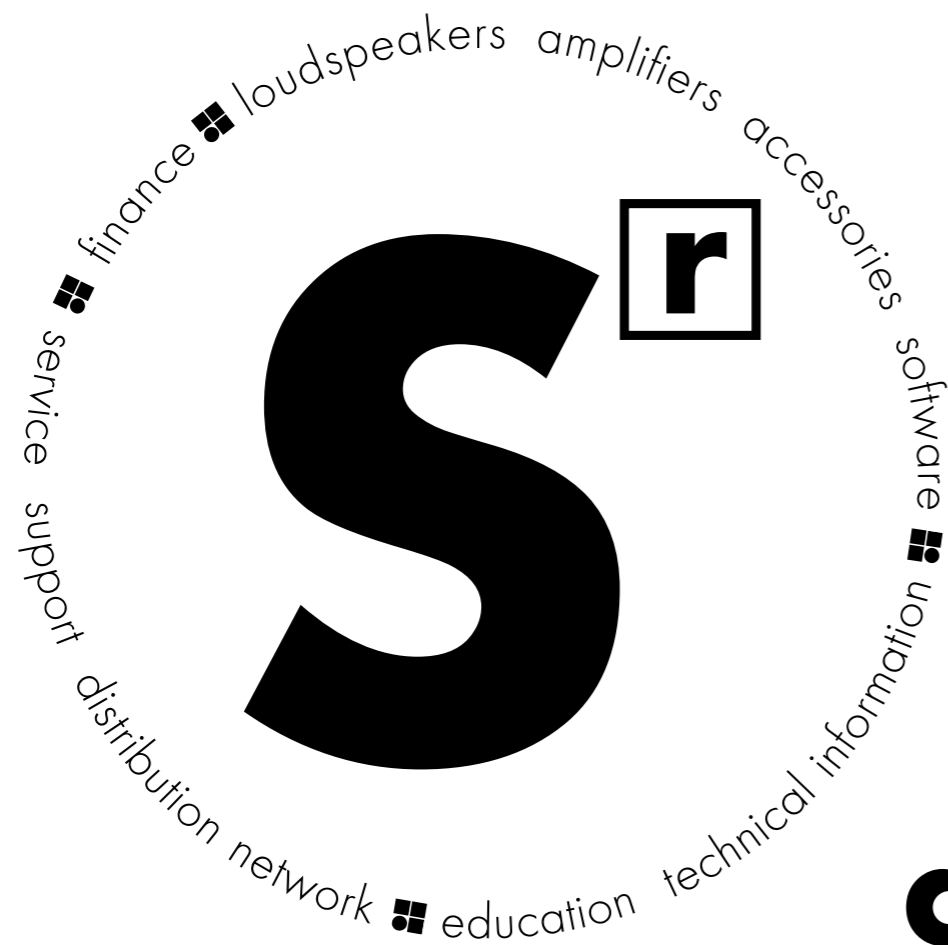

# d&b System reality

As the name implies a d&b audiotechnik system is not just a loudspeaker. Nor is it merely a sum of the components: loudspeakers, amplifiers, accessories and software. Right from the outset the d&b audiotechnik approach was to build integrated sound reinforcement systems that actually are

more than the combination of parts: an entirety where each fits all. Every element is tightly specified, precisely aligned and carefully matched to achieve maximum efficiency. For ease of use, all the user-definable parameters are incorporated, allowing the possibility of adjustment, either via remote control surfaces

or directly on the amplifiers. Neutral sound characteristics leave the user all the freedom needed to realize whatever the brief. At the same time d&b offers finance, service and support, a knowledgeable distribution network, education and training as well as technical information, so the same optimal acoustic result

is achieved consistently by every system anywhere, at any time. In reality: the d&b System reality.

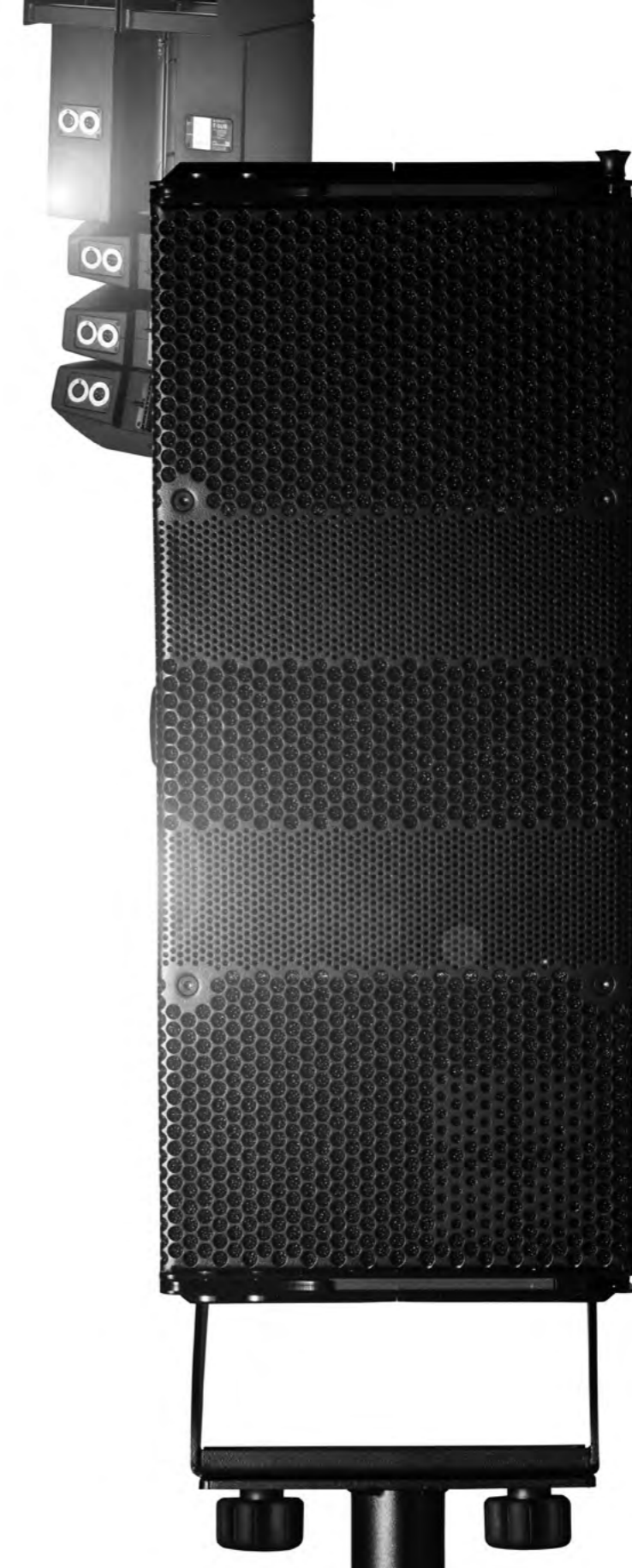

The **T-Series** offers two different loudspeaker technologies in one package delivering considerable performance as the smallest d&b line array and with a twist transforming into a stand-alone point source system. A fusion of techniques is used to deliver exemplary directivity control for situations where gain before feedback is an absolute requirement. These encompass

dipolar low frequency driver arrangements, high excursion drivers and a unique combination of rotatable horn and acoustic lens. The broad application scope of the T-Series ranges from small to medium sized applications. The unobtrusive visual design, compact dimensions, high power and exemplary directivity performance makes the T-Series loudspeakers a good choice in

many theatres, musicals, conference and presentation situations, live television and orchestral shows. The **T loudspeakers** integrate specially designed unobtrusive rigging and mounting allowing quick and simple deployment in changing environments with the clear perspective to provide mobile, flexible, configurable sound solutions. The **Ti loudspeakers** differ only in cabinet

construction and mounting hardware. They are intended for permanently installed performance spaces where the specification is rider driven by the artist or mix engineer's preferences. The Ti cabinets and mounting hardware are mechanically adapted for installation use, are weather protected for climatically hostile environments and can be colour matched to interior designs.

# The T-Series

The 2-way passive **T10** loudspeaker may be deployed in multiples as line array that maintains horizontal constant directivity down to approximately 600 Hz or as a high directivity point source loudspeaker. Accurate control of horizontal directivity is further enhanced by a large frequency overlap through the crossover range, while adaption for line source or point source orientation is achieved without the use of any tools. The T10 HF driver is fitted to a waveguide horn producing vertical line source directivity. Rotation of the horn by 90° produces an accurate point source dispersion transforming a vertically oriented T10 into a stand-alone full range loudspeaker. When the T10 is deployed upright as a point source, the vertical directivity control extends approximately one octave lower than similarly sized biaxial loudspeakers.

The installation specific **Ti10L** and **Ti10P** loudspeakers share the same characteristics, with different versions designed for varied applications: the Ti10L loudspeaker is used in multiples as elements of line arrays and incorporates appropriate rigging, whilst the Ti10P is used as a point source standalone loudspeaker without the line array hardware.

The **T** and **Ti** subwoofers are actively driven bass-reflex subwoofers utilizing a long excursion 15" neodymium driver, sharing the same width and integrated rigging fittings as the T10 and Ti10L respectively. They are used to increase the low frequency headroom and extend the bandwidth of a T10 and Ti10L column down to 47 Hz.



**T10 loudspeaker in line source orientation**

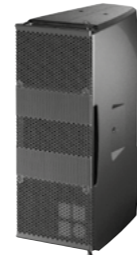

**T10 loudspeaker**



**Ti10L loudspeaker**



**Ti10P loudspeaker**

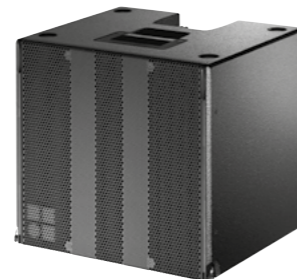

**T subwoofer**

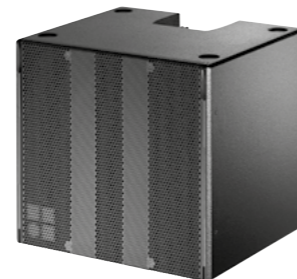

**Ti subwoofer**

The **B4-SUB** is intended for use in mobile applications. It's a compact high performance cardioid subwoofer utilizing two long excursion neodymium drivers in an integrated cardioid setup to avoid unwanted energy behind the system. This passive cardioid design is driven by a single amplifier channel and intended for ground stacked setups.

The d&b software offering aides the entire system setup process, from the simulation and planning of the loudspeaker systems, to the remote control and monitoring of the system functions during the event, followed by service functionality to verify system performance prior to de-rigging. The **ArrayCalc** simulation software allows the virtual optimization of loudspeaker line arrays, point source and column loudspeakers as well as subwoofers and their adjustment to venue conditions. The d&b **NoizCalc** software uses international standards to model noise immission from one or more d&b loudspeaker systems. NoizCalc takes data from ArrayCalc and calculates the sound propagation and relative attenuation values towards the far field. The complete system configuration simulated in ArrayCalc is assimilated by the **R1** Remote control software into an intuitive graphical user interface to manage the amplifiers, and loudspeakers, from anywhere in the venue. Service functions enable firmware updates of the amplifiers as and when these are available.

d&b amplifiers are specifically designed for use with d&b loudspeakers, and are at the heart of the d&b system approach. These devices contain extensive Digital Signal Processing capabilities to provide comprehensive loudspeaker management and specific switchable filter functions to precisely target the system response for a wide variety of applications. The four channel **D20** amplifier is specifically designed for mobile events comprising small to medium sound reinforcement solutions. The installation specific four channel **30D** amplifier is intended for permanent integration within venues which require medium Sound Pressure Levels. These amplifiers both provide extensive user-definable equalization containing two 16-band equalizers with parametric, notch, shelving and asymmetric filters as well as delay capabilities of up to 10 seconds.

The **DS10** Audio network bridge provides 16 AES3 outputs and interfaces between the Dante audio transport protocol and the d&b amplifiers.



**B4 subwoofer**



**D20 amplifier**



**30D amplifier**



**DS10 Audio network bridge**

# The T10 loudspeaker

## T10 loudspeaker

The T10 cabinet is a passive 2-way design that houses 2 x 6.5" drivers, a 1.4" exit HF compression driver and can be either used as a line source or high directivity point source loudspeaker. The very compact loudspeaker design is a unique combination of a rotatable waveguide with horn and an acoustic lens. The horn can easily be rotated from outside the loudspeaker without tools or removing the front grill. This is achieved through apertures at the cabinet sides which allow rotation to both the line and point source positions. The T10 provides a vertical line source with a 90° horizontal dispersion that is maintained down to approximately 600 Hz, whilst the integrated lens in the front grill widens the HF dispersion in line array mode to 105°. When the loudspeaker is used upright as a point source, the lens curves the wave front of the line source providing a 90° x 35° dispersion pattern. The two 6.5" neodymium LF drivers are positioned in a dipolar arrangement providing an exceptional dispersion control even at lower frequencies.

The T10 cabinet is constructed from polyurethane integral hard foam with an impact resistant finish and has integrated line array rigging hardware. The front of the loudspeaker cabinet is protected by a rigid metal grill backed by an acoustically transparent foam.

## System data

Frequency response (-5 dB standard) ..... 68 Hz - 18 kHz  
 Frequency response (-5 dB CUT mode)..... 120 Hz - 18 kHz  
 Max. sound pressure (Line/Arc setup • PS setup, 1 m, free field)<sup>1</sup>  
 with D6/10D ..... 129 • 127 dB  
 with D20/30D ..... 132 • 130 dB  
 with D80 ..... 132 • 130 dB  
 Input level (100 dB SPL/1 m) ..... -13 dBu

## Loudspeaker data

Nominal impedance ..... 16 ohms  
 Power handling capacity (RMS/peak 10 msec) ..... 200/800 W  
 Nominal dispersion angle (line source, horizontal) ..... 105°  
 Nominal dispersion angle (point source, h x v) ..... 90° x 35°  
 Components ..... 2 x 6.5" driver with neodymium magnet  
 ..... 1.4" exit compression driver on rotatable waveguide  
 ..... passive crossover network  
 Connections ..... 2 x NLT4 F/M  
 ..... optional 2 x EP5 or 2 x NL4  
 Weight ..... 11 kg (24 lb)

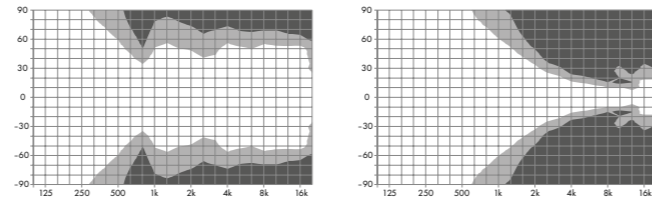

T10 horizontal dispersion characteristics, line source<sup>2</sup>

T10 vertical dispersion characteristics, line source<sup>2</sup>

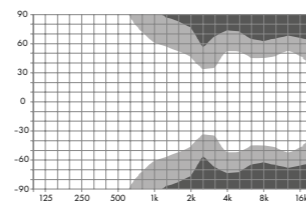

T10 horizontal dispersion characteristics, point source<sup>2</sup>

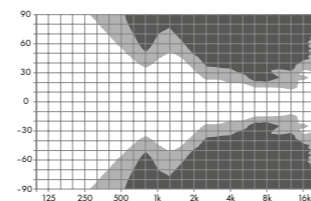

T10 vertical dispersion characteristics, point source<sup>2</sup>

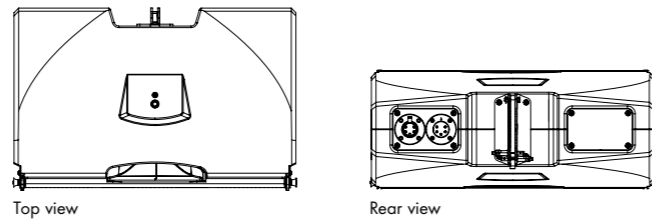
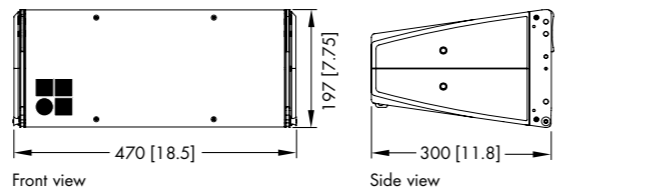

T10 cabinet dimensions in mm [inch]

<sup>1</sup> Broadband measurement, pink noise, crest factor 4, peak measurement, linear weighting  
<sup>2</sup> Dispersion angle vs frequency plotted using lines of equal sound pressure (isobars) at -6 dB and -12 dB

# The T10 electroacoustic concept

The unique combination of a rotatable waveguide with horn and an acoustic lens enables T10 to transform from line source to point source mode easily from outside without tools or removing the front grill. This provides a vertical line source with a 90° horizontal dispersion, whilst the integrated lens in the front grill widens the HF dispersion in line source mode to 105°. When the loudspeaker is used upright as a point source, the lens curves the wave front of the line source providing a 90° x 35° dispersion pattern.

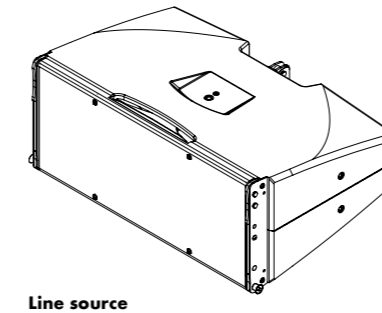

Line source

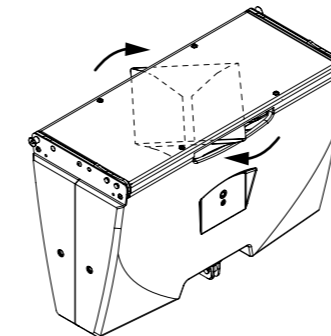

Rotating horn

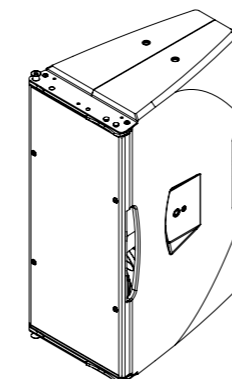

Point source

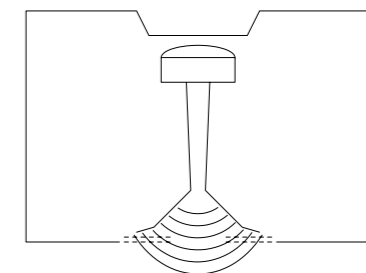
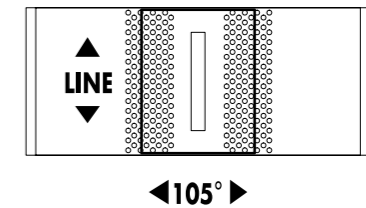

T10 horn and lens in line source setup

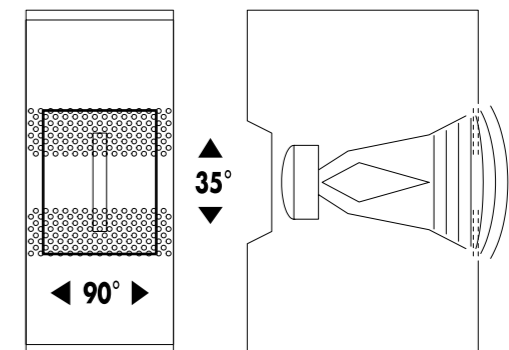

T10 horn and lens in point source setup

# The Ti10L loudspeaker

## Ti10L loudspeaker

The Ti10L loudspeaker is the installation version of the T10 for deployment as a line array loudspeaker. Road and installation versions differ only in the rigging hardware.

The Ti10L cabinet is a passive 2-way design that houses 2 x 6.5" drivers and a 1.4" exit HF compression driver. The very compact loudspeaker design is a unique combination of a rotatable waveguide with horn and an acoustic lens. It provides a vertical line source with a 90° horizontal dispersion that is maintained down to approximately 600 Hz, whilst the integrated lens in the front grill widens the HF dispersion in line array mode to 105°. The two 6.5" neodymium LF drivers are positioned in a dipolar arrangement providing an exceptional directivity control even at lower frequencies.

The Ti10L cabinet is constructed from polyurethane integral hard foam with an impact resistant finish and has integrated line array rigging hardware which, once deployed is fundamentally invisible when viewed from the front. The front of the loudspeaker cabinet is protected by a rigid metal grill backed by an acoustically transparent foam.

## System data

Frequency response (-5 dB standard)	68 Hz - 18 kHz
Frequency response (-5 dB CUT mode)	120 Hz - 18 kHz
Max. sound pressure (1 m, free field) <sup>1</sup>	
with D6/10D	129 dB
with D20/30D	132 dB
with D80	132 dB
Input level (100 dB SPL/1 m)	-13 dBu

## Loudspeaker data

Nominal impedance	16 ohms
Power handling capacity (RMS/peak 10 msec)	200/800 W
Nominal dispersion angle (h)	105°
Components	2 x 6.5" driver with neodymium magnet
	1.4" exit compression driver on rotatable waveguide
	passive crossover network
Connections	2 x NL4
Weight	11 kg (24 lb)

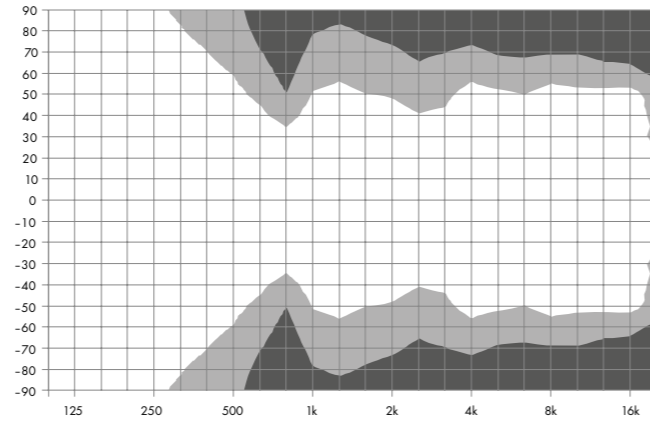

Ti10L horizontal dispersion characteristics<sup>2</sup>

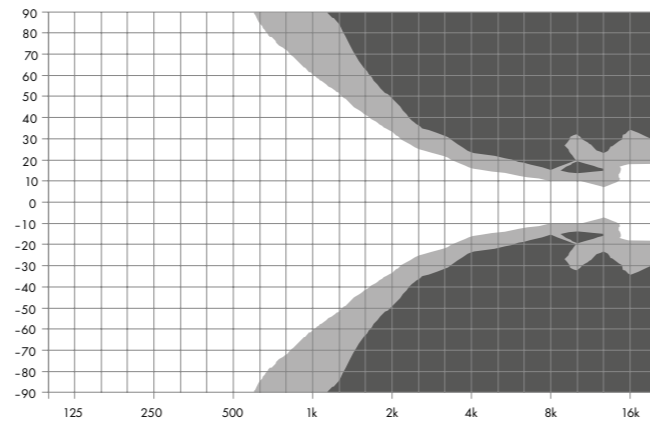

Ti10L vertical dispersion characteristics<sup>2</sup>

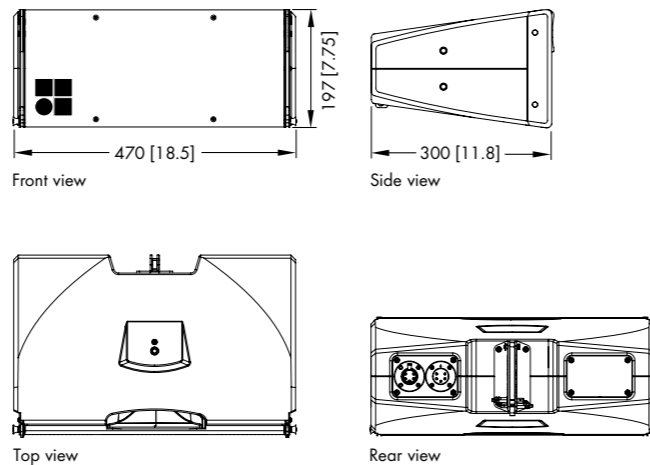

Ti10L cabinet dimensions in mm [inch]

<sup>1</sup> Broadband measurement, pink noise, crest factor 4, peak measurement, linear weighting  
<sup>2</sup> Dispersion angle vs frequency plotted using lines of equal sound pressure (isobars) at -6 dB and -12 dB

# The Ti10P loudspeaker

## Ti10P loudspeaker

The Ti10P loudspeaker is the installation version of the T10 for deployment as a point source loudspeaker. Road and installation versions differ only in the mounting hardware.

The Ti10P cabinet is a passive 2-way design that houses 2 x 6.5" drivers, a 1.4" exit HF compression driver and can be used either in horizontal or vertical orientation. The very compact loudspeaker design is a unique combination of a rotatable waveguide with horn and an acoustic lens. The horn can easily be rotated from outside the loudspeaker without tools or removing the front grill. This is achieved through apertures at the cabinet sides which allow rotation to both vertical or horizontal setup. It provides a vertical line source with a 90° horizontal dispersion that is maintained down to approximately 600 Hz, whilst the integrated lens in the front grill widens the HF dispersion in horizontal setup to 105°. When the loudspeaker is used upright, the lens curves the wave front of the line source providing a 90° x 35° dispersion pattern. The two 6.5" neodymium LF drivers are positioned in a dipolar arrangement providing exceptional directivity control even at lower frequencies.

The Ti10P cabinet is constructed from polyurethane integral hard foam with an impact resistant finish and has integrated threads for attaching installation hardware. The front of the loudspeaker cabinet is protected by a rigid metal grill backed by an acoustically transparent foam.

## System data

Frequency response (-5 dB standard)	68 Hz - 18 kHz
Frequency response (-5 dB CUT mode)	120 Hz - 18 kHz
Max. sound pressure (1 m, free field) <sup>1</sup>	
with D6/10D	127 dB
with D20/30D	130 dB
with D80	130 dB
Input level (100 dB SPL/1 m)	-13 dBu

## Loudspeaker data

Nominal impedance	16 ohms
Power handling capacity (RMS/peak 10 msec)	200/800 W
Nominal dispersion angle (h x v)	90° x 35°
Components	2 x 6.5" driver with neodymium magnet
	1.4" exit compression driver on rotatable waveguide
	passive crossover network
Connections	2 x NL4
Weight	10 kg (23 lb)

<sup>1</sup> Broadband measurement, pink noise, crest factor 4, peak measurement, linear weighting  
<sup>2</sup> Dispersion angle vs frequency plotted using lines of equal sound pressure (isobars) at -6 dB and -12 dB

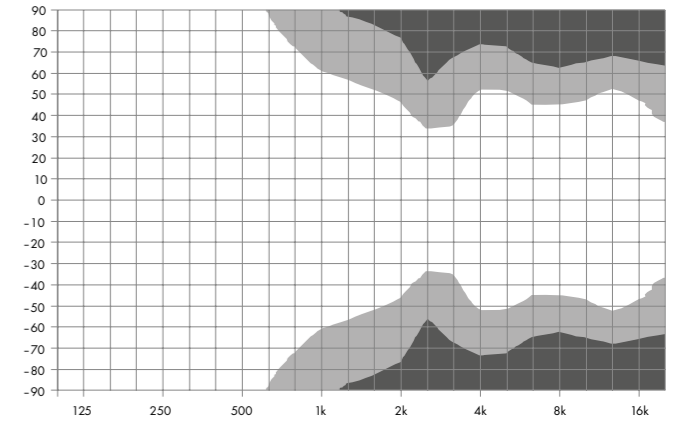

Ti10P horizontal dispersion characteristics<sup>2</sup>

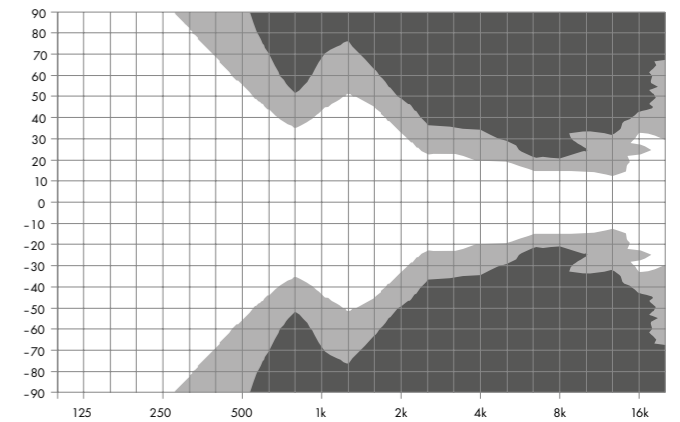

Ti10P vertical dispersion characteristics<sup>2</sup>

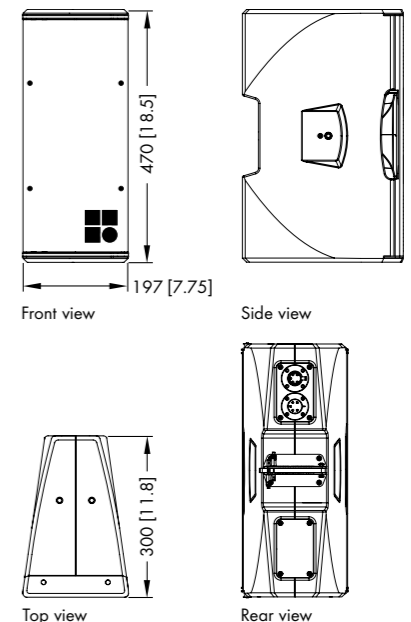

Ti10P cabinet dimensions in mm [inch]

# The T and Ti subwoofers

## T and Ti subwoofers

The T and Ti-SUB are actively driven bass-reflex designs housing a long excursion 15" driver with a neodymium magnet. They can be used to supplement the LF headroom of the T and Ti loudspeakers in various combinations, ground stacked or flown, either integrated on top of an array or as a separate column. They can also supplement the T10 and Ti10 loudspeakers respectively in ground stacked applications where the SUBs can mechanically support them.

The cabinets are mechanically connected using rigging links on both sides of the cabinet front which slide out when needed, and with a central splay link at the rear of the cabinet. All necessary rigging components are mounted to the cabinet. The T and Ti-SUB cabinets are constructed from marine plywood and have an impact resistant paint finish. The T-SUB cabinet has a handle mounted in the top panel. The front of the loudspeaker cabinets are protected by a rigid metal grill in front of an acoustically transparent foam.

## System data

Frequency response (-5 dB standard)	47 - 140 Hz
Frequency response (-5 dB 100 Hz mode)	47 - 100 Hz
Max. sound pressure (single cabinet, 1 m, free field) <sup>1</sup>	
with D6/10D	127 dB
with D20/30D	130 dB
with D80	130 dB

## Loudspeaker data

Nominal impedance	8 ohms
Power handling capacity (RMS/peak 10 msec)	300/1600 W
Components	15" driver with neodymium magnet
Connections T-SUB	2 x NLT4 F/M
	optional 2 x EP5 or 2 x NL4
Connections Ti-SUB	2 x NL4
Weight	17 kg (37 lb)

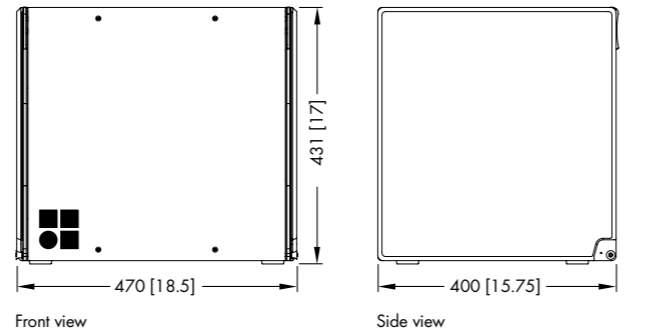

Front view

Side view

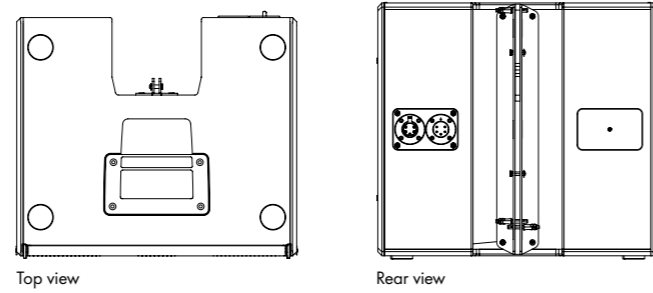

Top view

Rear view

T-SUB cabinet dimensions in mm [inch]

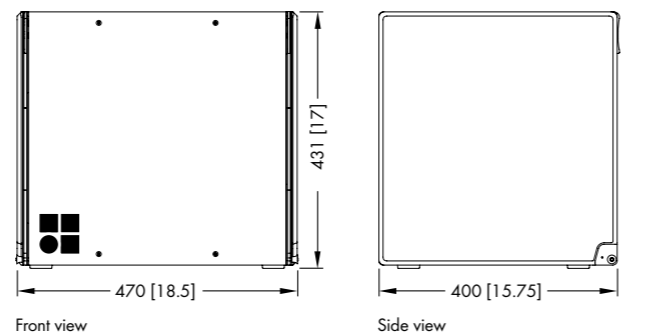

Front view

Side view

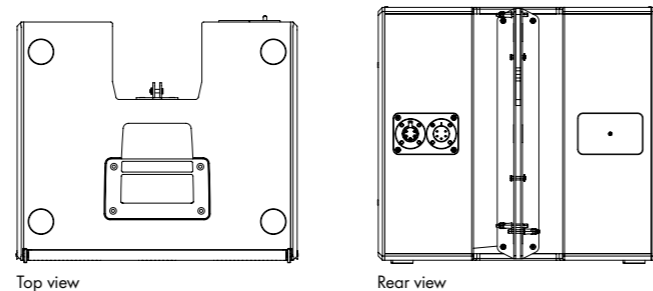

Top view

Rear view

Ti-SUB cabinet dimensions in mm [inch]

<sup>1</sup> Broadband measurement, pink noise, crest factor 4, peak measurement, linear weighting  
<sup>2</sup> Dispersion angle vs frequency plotted using lines of equal sound pressure (isobars) at -6 dB and -12 dB

# The B4 subwoofer

## B4 subwoofer

The B4-SUB is an actively driven cardioid subwoofer powered by a single amplifier channel. It houses two long excursion neodymium drivers in an integrated cardioid setup: a 15" driver in a bass-reflex design facing to the front and a 12" driver in a two chamber bandpass design radiating to the rear. The cardioid dispersion pattern resulting from this arrangement unwanted energy behind the system that greatly reduces the excitation of the reverberant field at low frequencies and provides the greatest accuracy of low frequency reproduction. The B4 subwoofer can only be used in a ground stacked configuration. The B4-SUB cabinet is constructed from marine plywood and has an impact and weather resistant paint finish and a pair of handles. An M20 threaded flange in the top panel accepts the d&b Loudspeaker stand winder M20. The front of the loudspeaker cabinet is protected by a rigid metal grill backed by an acoustically transparent foam. Two runners extend from the rear to the front panel of the cabinet protecting the bottom panel against scratching. Two correspondingly shaped recesses are incorporated in the top panel of each cabinet that accept these runners to prevent cabinet movement when stacked.

## System data

Frequency response (-5 dB standard)	40 - 150 Hz
Frequency response (-5 dB 100 Hz mode)	40 - 100 Hz
Max. sound pressure (1 m, free field) <sup>1</sup>	
with D6/10D	128 dB
with D20/30D	131 dB
with D80	131 dB

## Loudspeaker data

Nominal impedance	6 ohms
Power handling capacity (RMS/peak 10 msec)	500/2000 W
Components	
Front/Rear	15"/12" driver
Connections	2 x NLT4 F/M
	optional 2 x EP5 or 2 x NL4
Weight	44 kg (97 lb)

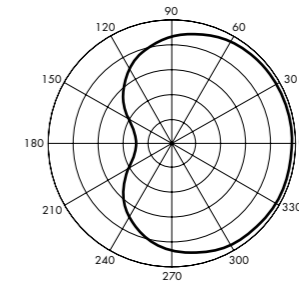

Cardioid polar pattern

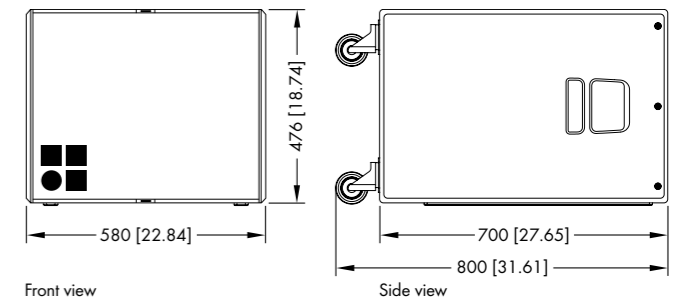

Front view

Side view

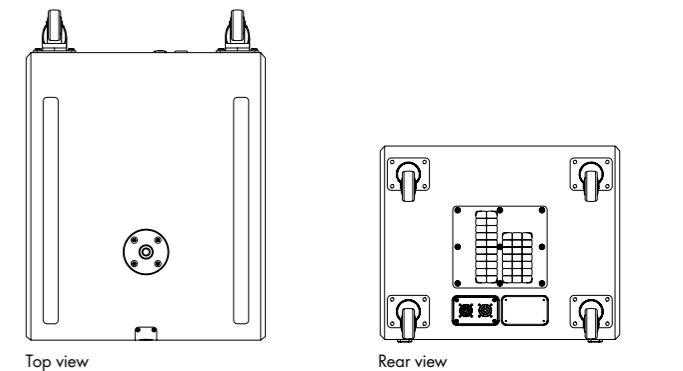

Top view

Rear view

B4-SUB cabinet dimensions in mm [inch]

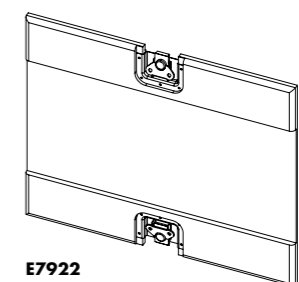

E7922  
B4-SUB Wooden lid

<sup>1</sup> Broadband measurement, pink noise, crest factor 4, peak measurement, linear weighting



# The T-Series rigging and mounting accessories

# The T-Series rigging and mounting examples

## Safety approval

d&b loudspeakers and accessories are designed for setup and use within situations requiring compliance with the provisions and directives of the DGUV regulation 17 (formerly BGV C1).

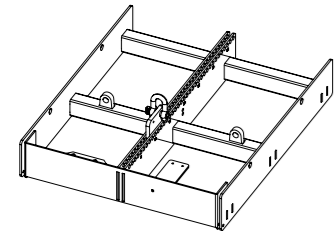

**Z5370**  
T Flying frame  
2 x Z5160 Q Load adapter supplied with each T Flying frame

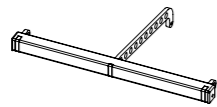

**Z5374**  
Ti Flying bar

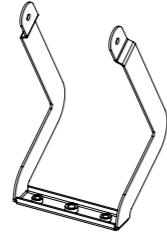

**Z5371**  
T Flying bracket

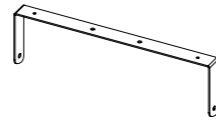

**Z5372**  
T Horizontal bracket

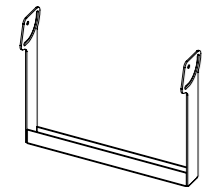

**Z5373**  
T Cluster bracket  
for up to 3 x T10/Ti10L

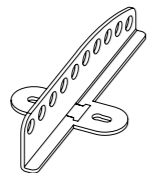

**Z5354**  
E8/E12 Flying adapter



**Z5355**  
E8/E12 Flying adapter link

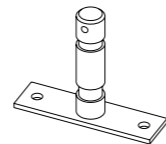

**Z5010**  
TV spigot with fixing plate

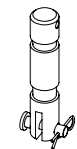

**Z5015**  
TV spigot for  
Flying adapter 02

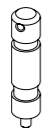

**Z5029**  
TV spigot M10

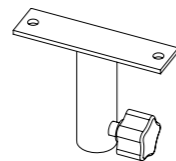

**Z5024**  
Loudspeaker stand adapter

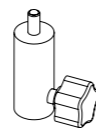

**Z5034**  
Stand adapter M10

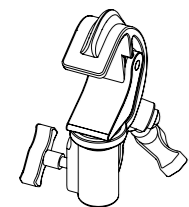

**Z5012**  
Pipe clamp for TV spigot  
For a tube diameter up to 70 mm/2.75"

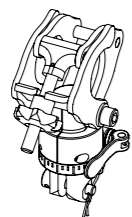

**Z5147**  
Rota clamp  
WLL: 500 kg (1100 lb)  
for a tube diameter up to 51 mm/2"



**Z5155**  
Q Hoist  
connector chain



**E6507**  
1t Shackle

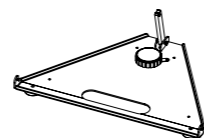

**Z5375**  
T Base plate  
for T10 with B4 and Q-SUB only

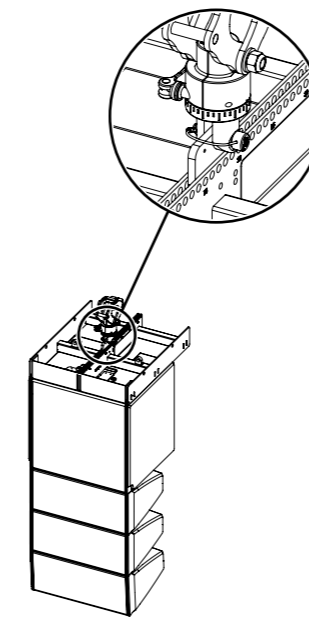

**T10/T-SUB or Ti10L/Ti-SUB**  
line array with  
Z5370 T Flying frame  
Z5147 Rota clamp

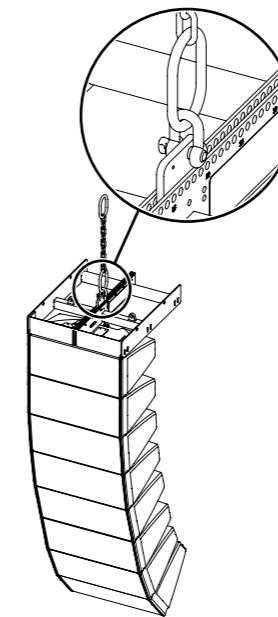

**T10 or Ti10L line array with**  
Z5370 T Flying frame  
Z5155 Q Hoist connector chain  
E6507 1t Shackle

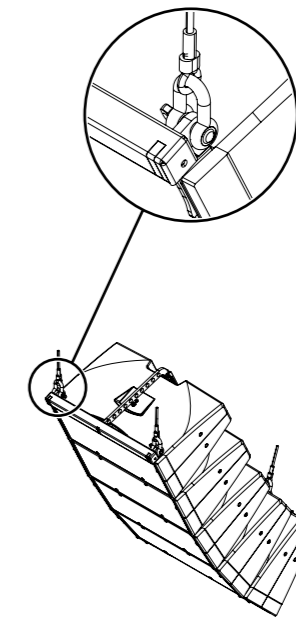

**Ti10L line array with**  
Z5374 Ti Flying bar  
E6507 1t Shackle

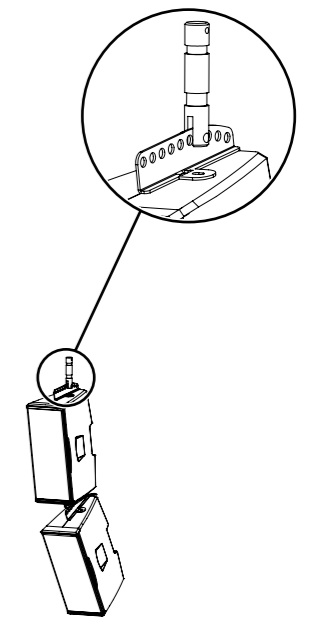

**T10 point source or Ti10P**  
as vertical array with  
Z5354 E8/E12 Flying adapter  
Z5355 E8/E12 Flying adapter link  
Z5015 TV spigot 02

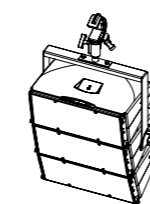

**3 x T10 or Ti10L line array with**  
Z5373 T Cluster bracket  
Z5010 TV spigot with fixing plate  
Z5012 Pipe clamp for TV spigot



**T10 point source or Ti10P with**  
Z5371 T Flying bracket  
Z5010 TV spigot with fixing plate  
Z5012 Pipe clamp for TV spigot

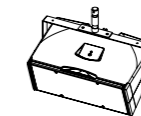

**T10 point source or Ti10P with**  
Z5372 T Horizontal bracket  
Z5010 TV spigot with fixing plate

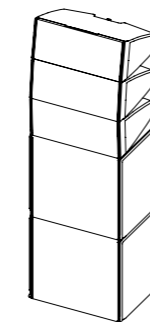

**T10/T-SUB or Ti10L/Ti-SUB**  
ground stack

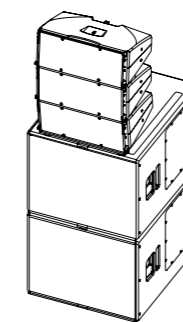

**T10/B4-SUB ground stack**  
with Z5375 T Base plate

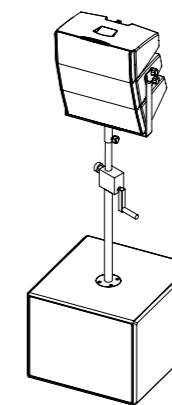

**T10 or Ti10L line array**  
on Q-SUB with  
Z5373 T Cluster bracket  
Z5013 Loudspeaker stand winder M20  
Z5024 Loudspeaker stand adapter

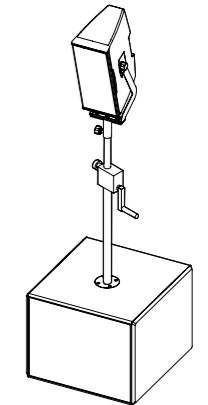

**T10 point source or Ti10P**  
on E15X-SUB with  
Z5371 T Flying bracket  
Z5013 Loudspeaker stand winder M20  
Z5024 Loudspeaker stand adapter

# The Ti Weather Resistant and Special Colour options

The Weather Resistant and Special Colour options are only available to order with the Ti version cabinets.

## Weather Resistant (WR) option

The WR option enables operation of loudspeakers in changing ambient conditions, however it is not intended to enable permanent, unprotected operation of loudspeakers outdoors. Cabinets being used outdoors even with the WR option should always be aimed either horizontally or with a downward tilt. An additional cover should be positioned over the loudspeakers. Ti loudspeakers with the Weather Resistant option are supplied with a fixed cable. Cable type H-07-RN-F 2 x 2.5 mm<sup>2</sup>/AWG 13 with a length of 5.5 m (18 ft) as standard or length as required.

## Special Colour (SC) option

The paint finish of all loudspeaker cabinets and most accessories can be executed in almost all RAL colours in accordance with the RAL colour table. Items such as chains, fixing screws, shackles, eyebolts and screws are not painted. Other paint finishes such as metallic are available on request. The acoustically transparent foam fitted behind the rigid metal grill is also painted with the requested RAL colour.

# The T-Series cases

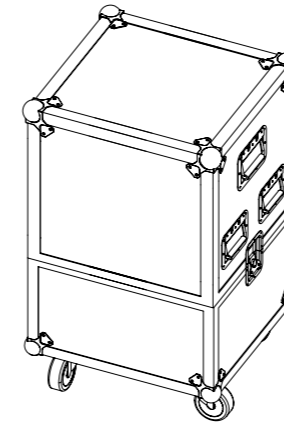

**E7451**  
Touring case 4 x T10

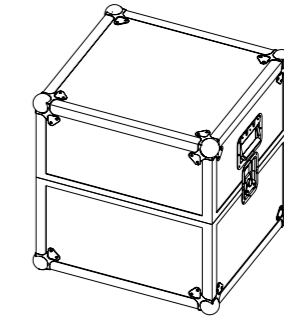
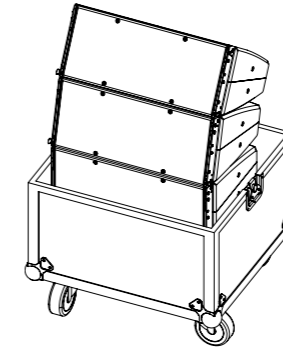

**E7453**  
Touring case 2 x T-SUB

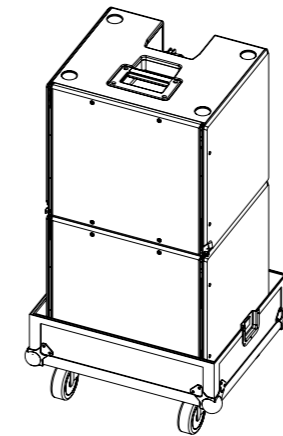

**E7455**  
Touring case 2 x T Flying frame

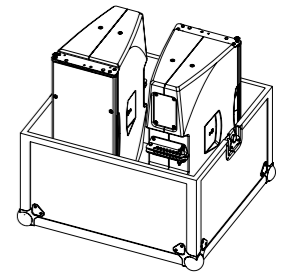

**E7452**  
Touring case 2 x T10

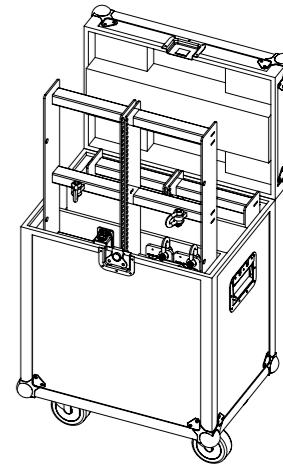

# The d&b ArrayCalc simulation software

## The d&b NoizCalc immission modelling software

The d&b ArrayCalc simulation software is the simulation tool for d&b line arrays, column and point source loudspeakers as well as subwoofers. This is a comprehensive toolbox for all tasks associated with acoustic design, performance prediction, alignment, rigging and safety parameters. d&b ArrayCalc is available as a native stand-alone application for both Microsoft Windows<sup>1</sup> and Mac OS X<sup>2</sup> operating systems. Listening planes can be defined in the venue tab, creating a three dimensional representation of any audience area in a given venue. All sources can be time aligned, and the phase response of a flown system and a ground stacked SUB array can be aligned at a definable reference point. The level distribution resulting from the interaction of all active sources can be mapped onto the audience areas in a three-dimensional view. The Remote ID for all devices can be managed in the amplifier tab. EASE and DXF data export capabilities are also available.

The ArrayProcessing function applies powerful filter algorithms to optimize the tonal (spectral) and level (spatial) performance of a line array column over the audience area defined by its mechanical vertical coverage angle. Spectral and level performance targets over the listening areas can be defined while specific level drops or offsets can be applied to certain areas using the Reflecting or Level avoidance plane types. It applies a combination of FIR and IIR filters to each cabinet in an array to achieve the targeted performance, with an additional latency of only 5.9 ms. This significantly improves the linearity of the response over distance as well as seamlessly correcting for air absorption. In addition, it employs the same frequency response targets for all d&b line arrays providing consistent sonic results widely regardless of array lengths or splay settings. The resulting coverage is enhanced with spectral consistency and defined level distribution, achieving better dispersion and total system directivity to cover listening areas effectively. A reference point can be defined for the d&b NoizCalc software, which can be used to model the far field noise immission from a d&b sound reinforcement system. NoizCalc uses loudspeaker data from the ArrayCalc simulation file and displays the immission on a terrain map, presenting the calculated Sound Pressure Levels in dB(A) applying the selected frequency spectrum using either the ISO 9613-2 or Nord2000 standards. The R1 Remote control software uses the data defined in ArrayCalc to generate an intuitive graphical user interface including the complete setup of the simulated system and all configuration information. This workflow removes the need to manually transfer data from one software program to the other. Further information is provided in the d&b Amplifier and Software brochure which is available for download at [www.dbaudio.com](http://www.dbaudio.com).

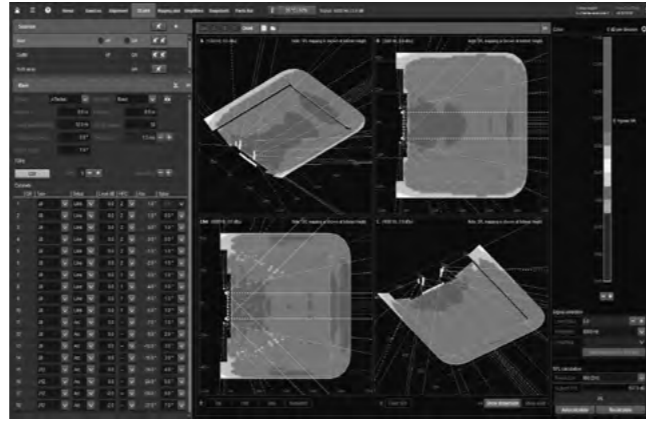

3D Plot quad



ArrayProcessing



NoizCalc results map

<sup>1</sup> Microsoft Windows is a registered trademark or trademark of Microsoft Corporation in the United States and/or other countries  
<sup>2</sup> Mac OS X is a trademark of Apple Inc., registered in the U.S. and other countries

# The d&b R1 Remote control software

The remote control capability of the d&b Remote network enables central control and monitoring of a complete d&b loudspeaker system from anywhere in the network, be it from a computer in the control room, at the mix position, or on a wireless tablet in the auditorium. This central access to all functions through the d&b Remote network, to controls as well as detailed system and device diagnostics information, unlocks the full potential of the d&b system approach. In a typical user workflow, the d&b Remote network takes settings optimized in the ArrayCalc simulation software and applies these to all the amplifiers within the network. The importation of settings from ArrayCalc allows the system configuration to be quickly accomplished, providing more time for verification and fine tuning.

All features, functions and controls available on the front panel of d&b amplifiers may be remotely controlled and/or monitored using R1 Remote control software. This allows each channel of the amplifier to be controlled and enables the creation of groups of loudspeakers. When grouped together, a button or fader can control the overall system level, zone level, equalization and delay, power ON/OFF, MUTE, as well as loudspeaker specific function switches such as CUT/HFA/HFC and CPL. An offline mode is provided for preparation in advance of an event, without the amplifiers being present or connected.

For mobile applications, d&b System check verifies that the system performs within a predefined condition. Extensive facilities for storing and recalling system settings are provided allowing these to be repeated, as and when required. Project files can be easily adjusted for use with a different set of equipment at another location.

In installation projects system integrators can configure the d&b Remote network to offer access to different levels of control, tailored to the operational demands. For example, power ON/OFF for daily use, or more complex functionality for detailed control. Password protection is available to restrict access. Input and Load monitoring allow installation operators to ensure optimum performance at all times.

R1 Remote control software enables d&b amplifiers to be remotely controlled using both Ethernet and CAN-Bus in parallel. The software is optimized for use with touch screen, mouse and keyboard and runs on both Microsoft Windows<sup>1</sup> (Win7 or higher) and Mac OS X<sup>2</sup> (10.7 or higher) operating systems. Further information is provided in the d&b Amplifier and Software brochure which is available for download at [www.dbaudio.com](http://www.dbaudio.com).



Home



Remote in Configuration mode

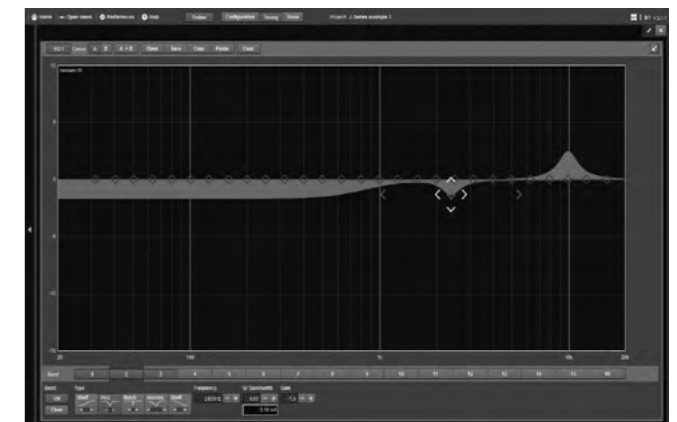

16-band equalizer

<sup>1</sup> Microsoft Windows is a registered trademark or trademark of Microsoft Corporation in the United States and/or other countries  
<sup>2</sup> Mac OS X is a trademark of Apple Inc., registered in the U.S. and other countries

# The d&b amplifiers

The d&b amplifiers are designed specifically to power d&b loudspeakers and are the beating heart of the d&b System reality. As such, they incorporate Digital Signal Processing for comprehensive loudspeaker management, switchable filter functions, remote capabilities and user-definable controls, to fulfil the exact needs of each application. Every loudspeaker configuration combines comprehensive system limiting, and equalization and crossover settings to ensure consistent results and optimal performance. d&b amplifiers offer

different output configurations for different loudspeaker setups, including Dual Channel mode, for passive setups, Mix TOP/SUB mode, in which two channels are driven through a single output connector, and 2-Way Active mode, which also sends the output of two channels down one connector to drive appropriate loudspeakers actively. The d&b switch functions provide selected filters to precisely tailor a wide variety of setups to their applications. Examples of these switch functions are the CSA (Cardioid Subwoofer Array)

and HFC (High Frequency Compensation) modes. CSA increases low frequency directivity control by minimising energy transmission towards the rear while HFC compensates for air absorption for loudspeakers covering far field listening positions. In addition to these functions, d&b amplifiers offer a comprehensive set of specific filters such as CUT, a cut mode for TOP loudspeakers when used with d&b subwoofers; CPL, to compensate for the coupling effect between loudspeakers in close proximity to other loudspeakers or hard objects and HFA

mode, to attenuate the high frequencies of a loudspeaker to mimic the effect of far field listening. These devices offer extended, user-definable equalization and delay capabilities, eliminating the need for external processing devices in the signal chain. All d&b amplifiers integrate with the d&b Remote network to enable the remote control and management of systems from anywhere within a network. Further information is provided in the d&b Amplifier and Software brochure which is available for download at [www.dbaudio.com](http://www.dbaudio.com).

## Comparison of the d&b amplifiers

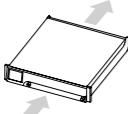
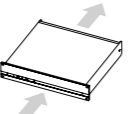
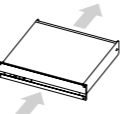
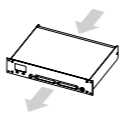
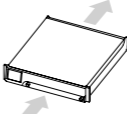
	D20	30D	10D	D6	D80
<b>User interface</b>	Encoder/colour TFT touchscreen	LED indicators	LED indicators	Encoder/LC display	Encoder/colour TFT touchscreen
<b>Output channels</b>	4	4	4	2	4
<b>Input channels</b>	4 x AES3 or 4 x analog or 2 x AES3 and 2 x analog	4 x AES3 and 4 x analog	4 x AES3 and 4 x analog	2 x AES3 or 2 x analog	4 x AES3 or 4 x analog or 2 x AES3 and 2 x analog
<b>Latency</b>	0.3 msec	0.3 msec	0.3 msec	0.3 msec	0.3 msec
<b>User equalizers (per channel)</b>	2 x 16-band	2 x 16-band	2 x 16-band	4-band	2 x 16-band
<b>Delay</b>	10 sec/3440 m	10 sec/3440 m	10 sec/3440 m	340 msec/116.9 m	10 sec/3440 m
<b>Maximum output power (THD+N &lt; 0.5%, 12 dB crest factor)</b>	4 x 800 W into 8 ohms 4 x 1600 W into 4 ohms	4 x 800 W into 8 ohms 4 x 1600 W into 4 ohms	4 x 350 W into 8 ohms 4 x 700 W into 4 ohms	2 x 350 W into 8 ohms 2 x 600 W into 4 ohms	4 x 2000 W into 8 ohms 4 x 4000 W into 4 ohms
<b>Output routing</b>	Dual Channel, Mix TOP/SUB 2-Way Active	Dual Channel, Mix TOP/SUB 2-Way Active	Dual Channel, Mix TOP/SUB 2-Way Active	Dual Channel	Dual Channel, Mix TOP/SUB 2-Way Active
<b>Output connectors</b>	NL4 plus central NL8	Phoenix Euroblock	Phoenix Euroblock	NL4	NL4/EP5 plus central NL8
<b>GPIO connector, 5 ports</b>	No	Phoenix Euroblock	Phoenix Euroblock	No	No
<b>Cable compensation</b>	LoadMatch	LoadMatch	LoadMatch	No	LoadMatch
<b>Power supply</b>	Universal range switched mode power supply with active PFC	Universal range switched mode power supply with active PFC	Universal range switched mode power supply with active PFC	Autosensing switched mode power supply with active PFC	Autosensing switched mode power supply with active PFC
<b>Mains voltage</b>	100 - 240 V, 50 - 60 Hz	100 - 240 V, 50 - 60 Hz	100 - 240 V, 50 - 60 Hz	100 - 120/220 - 240, 50 - 60 Hz	100 - 127/208 - 240 V, 50 - 60 Hz
<b>Weight (kg/lb)</b>	10.8/23.8	10.6/23.4	10.6/23.4	8/17.6	19/42
<b>Dimensions</b>	2 RU x 19" x 460 mm	2 RU x 19" x 435 mm	2 RU x 19" x 435 mm	2 RU x 19" x 353 mm	2 RU x 19" x 530 mm
<b>Remote</b>	OCA via Ethernet/CAN	OCA via Ethernet/CAN	OCA via Ethernet/CAN	CAN	OCA via Ethernet/CAN
<b>Airflow</b>					

# The operation with d&b amplifiers

## Amplifier controller setups

### Arc, Line and PS (point source) mode

The Line or Arc modes are selected when the T10/Ti10L loudspeakers are used as a line array. The chosen configuration will depend on the curvature of the array. The Line configuration is selected when groups of four or more cabinets are coupled in a straight long throw array section, where the splay angles to adjacent cabinets are 0° to 2°. The Arc configuration is selected when cabinets are used in curved array sections, where the splay angles to adjacent cabinets are 3° or more. Within a typical array both amplifier configurations are used. The PS configuration is selected when the Ti10P is used in either horizontal or vertical orientation or the T10 is used as a single spherical loudspeaker.

### CUT mode

Set to CUT, the cabinet low frequency level is reduced and is configured for use with d&b active subwoofers.

### HFC mode

Selecting the HFC (High Frequency Compensation, Line or Arc mode only) mode compensates for loss of high frequency energy due to absorption in air when loudspeakers are used to cover far field listening positions. The HFC mode has two different settings, which should only be used for those cabinets covering the following respective distances: HFC1 for distances between 25 m (80 ft) and 50 m (160 ft), and HFC2 for distances further than 50 m (160 ft). This enables the correct sound balance between close and remote audience areas, whilst all amplifiers driving the array can be fed with the same signal.

### HFA mode

Selecting HFA mode (High Frequency Attenuation, PS setup only), the HF response is rolled off. The HFA provides a natural, balanced frequency response when a unit is placed close to listeners in near field or delay use. HFA begins gradually at 1 kHz, dropping by approximately 3 dB at 10 kHz. This roll off mimics the decline in frequency response experienced when listening to a system from a distance in a typically reverberant room or auditorium.

### CPL function

The CPL (Coupling) function compensates for coupling effects between closely coupled cabinets by reducing the low and mid

frequency level. CPL begins gradually at 1 kHz, with the maximum attenuation below 400 Hz, providing a balanced frequency response when cabinets are used in arrays of four or more. The CPL function can be set in dB attenuation values between -9 and 0, or a positive CPL value which creates an adjustable low frequency boost around 65 Hz (0 to +5 dB).

### 100 Hz mode

The 100Hz mode limits the upper operating frequency of the subwoofer to 100Hz, complementing top cabinets in full range mode.

### Recommended amplifiers for mobile applications

	T10	T-SUB	B4-SUB
<b>D20</b>	x	x	x

### Recommended amplifiers for installation applications

	Ti10L	Ti10P	Ti-SUB
<b>30D</b>	x	x	x

### Maximum loudspeakers per amplifier channel

	T10	Ti10L	Ti10P	T-SUB/ Ti-SUB	B4-SUB
	4	4	4	2	2

### Available controller settings

	T10	Ti10L	Ti10P	T-SUB/ Ti-SUB	B4-SUB
<b>Arc, Line</b>	x	x			
<b>PS</b>	x		x		
<b>CUT</b>	x	x	x		
<b>HFC</b>	x	x			
<b>HFA</b>	x		x		
<b>CPL</b>	x	x	x		
<b>100 Hz</b>				x	x

# The T-Series frequency responses

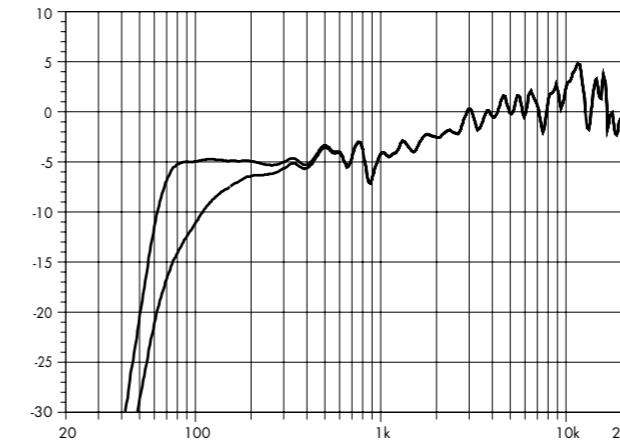

T10 line source/Ti10L standard and CUT (single cabinet)

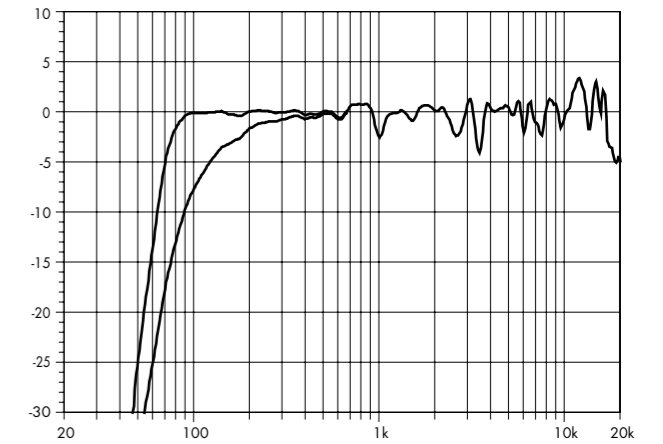

T10 point source/Ti10P standard and CUT

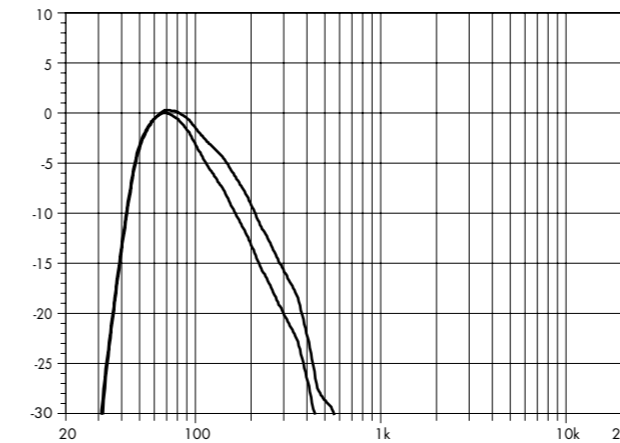

M6 standard and CUT (floor coupling)

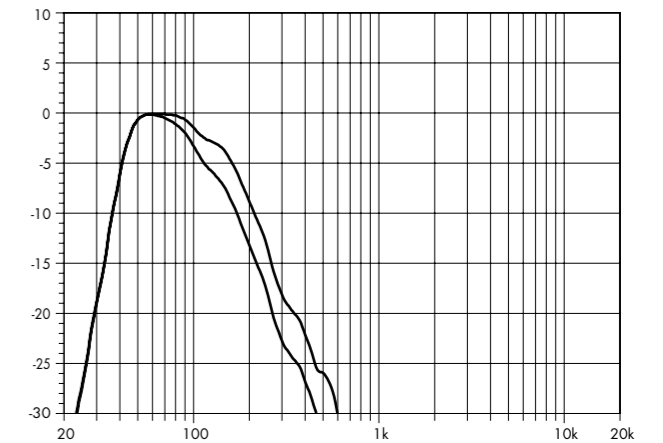

B4-SUB standard and 100 Hz

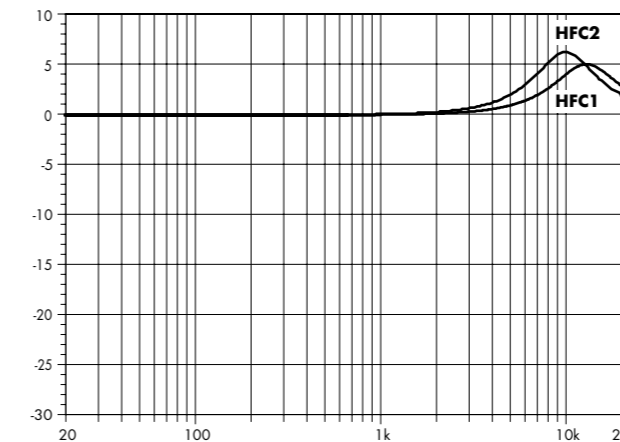

Correction of HFC

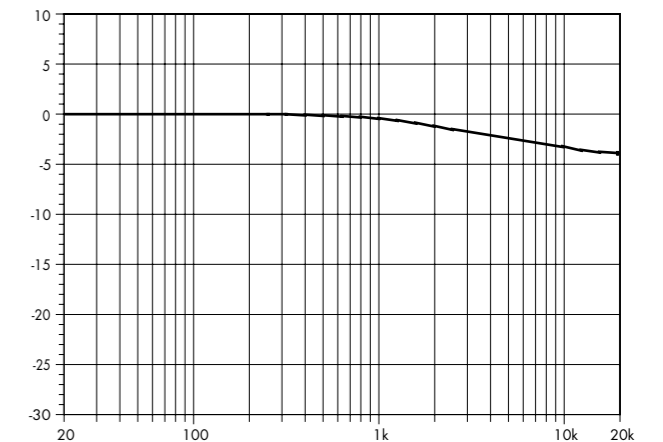

Correction of HFA

# The d&b amplifier output modes

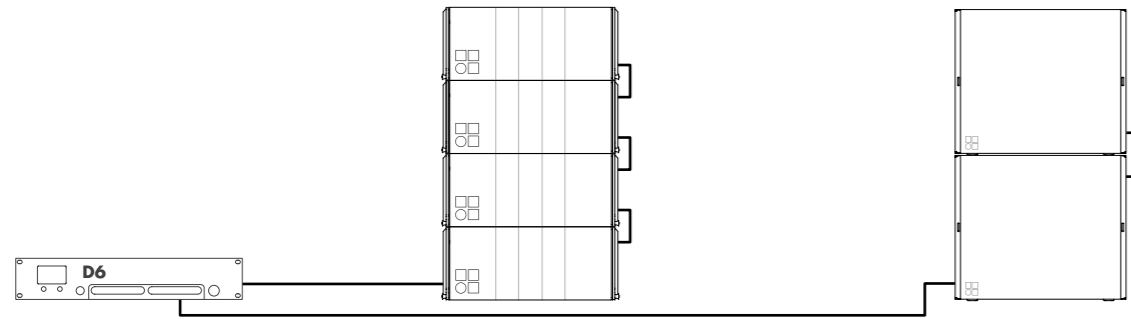

**D6 amplifier in Dual Channel mode for T10, Ti10L or Ti10P and T-SUB, Ti-SUB or B4-SUB**

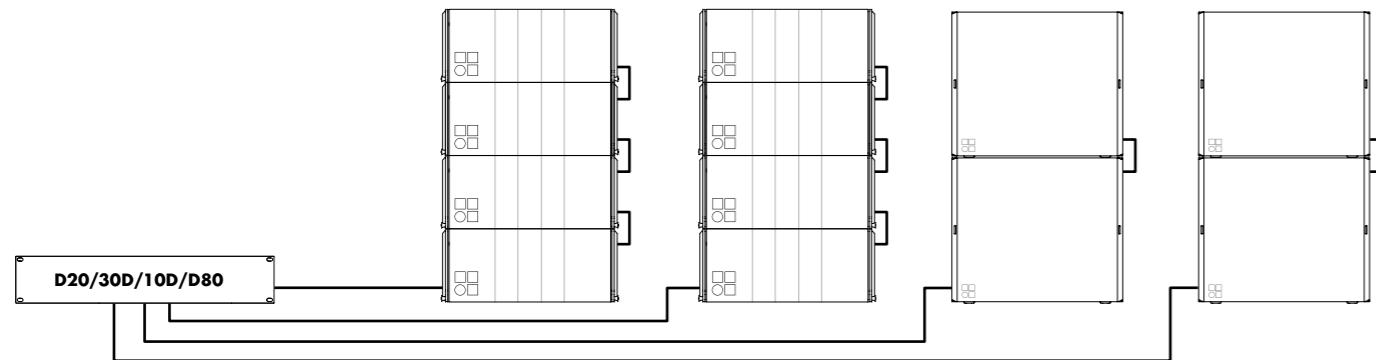

**D20/30D/10D/D80 amplifier in Dual Channel mode for T10, Ti10L, Ti10P, T-SUB, Ti-SUB and B4-SUB<sup>1</sup>**

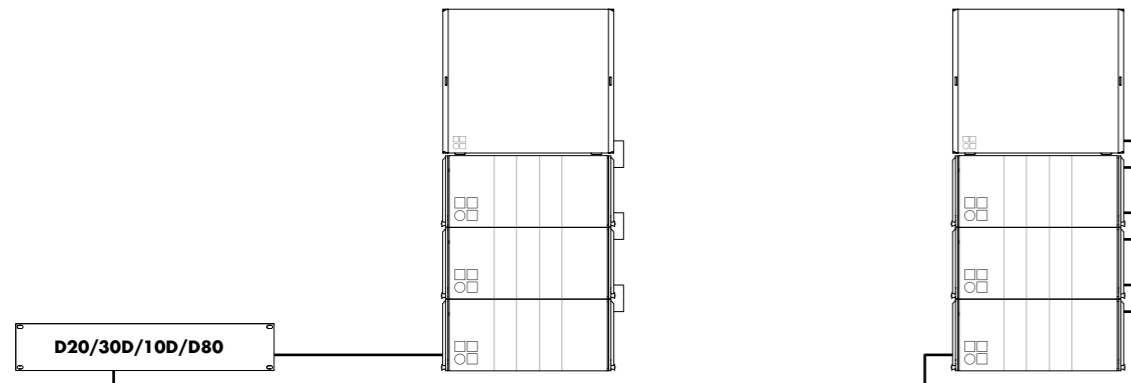

**D20/30D/10D/D80 amplifier in Mix TOP/SUB mode for T10, Ti10L, Ti10P, T-SUB, Ti-SUB and B4-SUB<sup>1</sup>**

# The DS10 Audio network bridge

The DS10 Audio network bridge interfaces between Dante networks and AES3 digital audio signals, while also providing distribution of Ethernet control data. Positioned within the signal chain in front of the amplifiers, this 1 RU device expands the d&b system approach in both mobile and installation environments. Each unit can deliver up to sixteen Dante network channels via AES3 digital signal outputs. The AES3 channel streams from the DS10 carry meta data with Dante channel labels and cabling information to the four channel d&b amplifiers. Additionally, four AES3 input channels provide access to the Dante audio network for applications such as a break-in from a Front of House console. The DS10 incorporates an integrated 5-port switch, offering a primary and redundant network for the Dante protocol, as well as advanced functions such as Multicast Filtering and VLAN modes. This extensive switch flexibility provides extended connectivity for a laptop to control the d&b amplifiers using the R1 Remote control software via the OCA (Open Control Architecture) protocol. Using the DS10 Audio network bridge, audio signals and remote control data can be combined using a single Ethernet cable. The DS10 features a power supply suitable for mains voltages 100 V - 240 V, 50 - 60 Hz, with Overvoltage protection of up to 400 V.

## Control and indicators

BYPASS/NETWORK..... Toggle switch  
 Switch port modes/Audio loss..... LED indicators  
 SYNC ERROR .....Red LED indicator  
 SUBSCRIBED (RX Subscription) ..... Green LED indicator

## Connectors

DIGITAL IN.....3 pin XLR female AES3  
 Input sampling ..... 32 - 192 kHz  
 Input synchronization..... Sample Rate Converter (SRC)  
 DIGITAL OUT .....3 pin XLR male AES3  
 Output sampling ..... 48/96 kHz  
 Output synchronization .....Dante network  
 Network .....etherCON<sup>1</sup>  
 ..... built-in 5-port Ethernet switch  
 ..... 100/1000 Mbit

## Power supply

Mains connector.....powerCON<sup>1</sup>  
 Rated mains voltage ..... 100 - 240 V, 50 - 60 Hz

## Dimensions, weight

Height x width x depth.....1 RU x 19" x 232 mm  
 Weight..... 3.75 kg (8.26 lb)

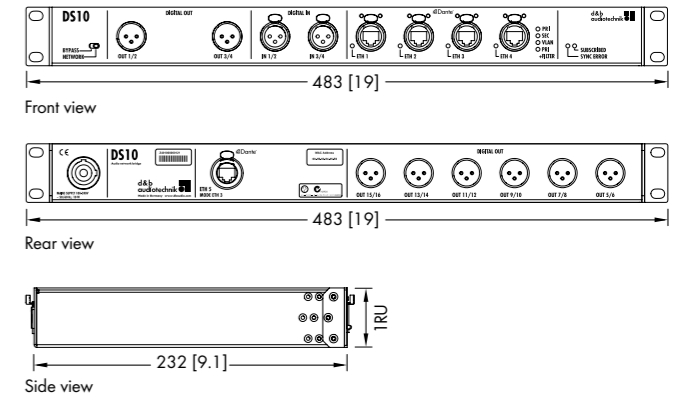

**DS10 Audio network bridge dimensions mm [inch]**

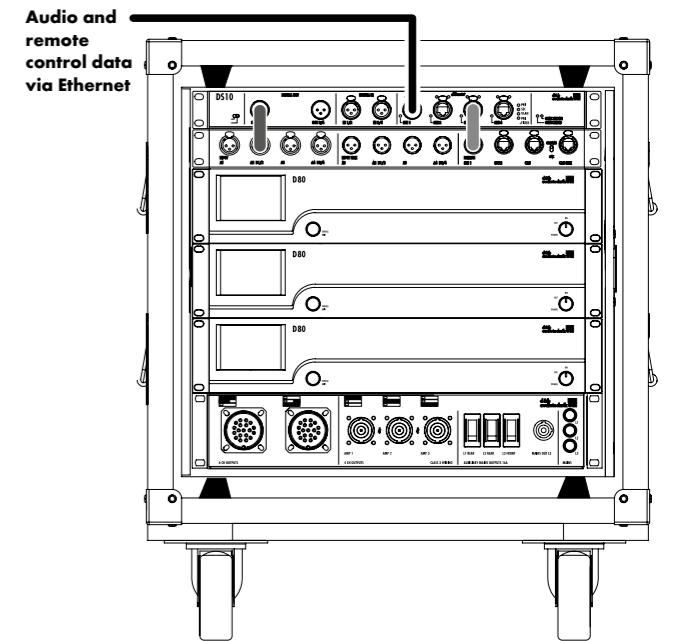

**DS10 sending audio and remote control data to D80 amplifiers**

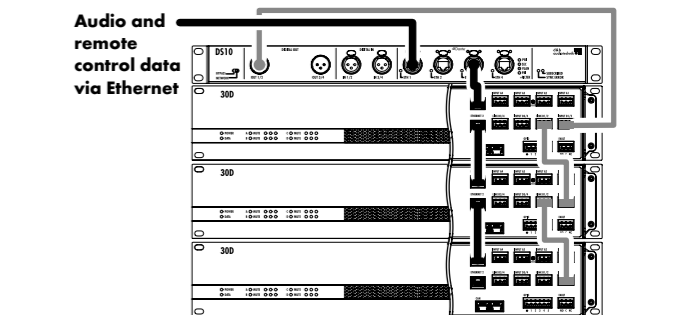

**DS10 sending audio and remote control data to 30D amplifiers**

<sup>1</sup> Dual Channel mode and Mix TOP/SUB mode can be used together in a mixed configuration

# The T-Series cables and adapters

## Amplifiers in Dual Channel mode

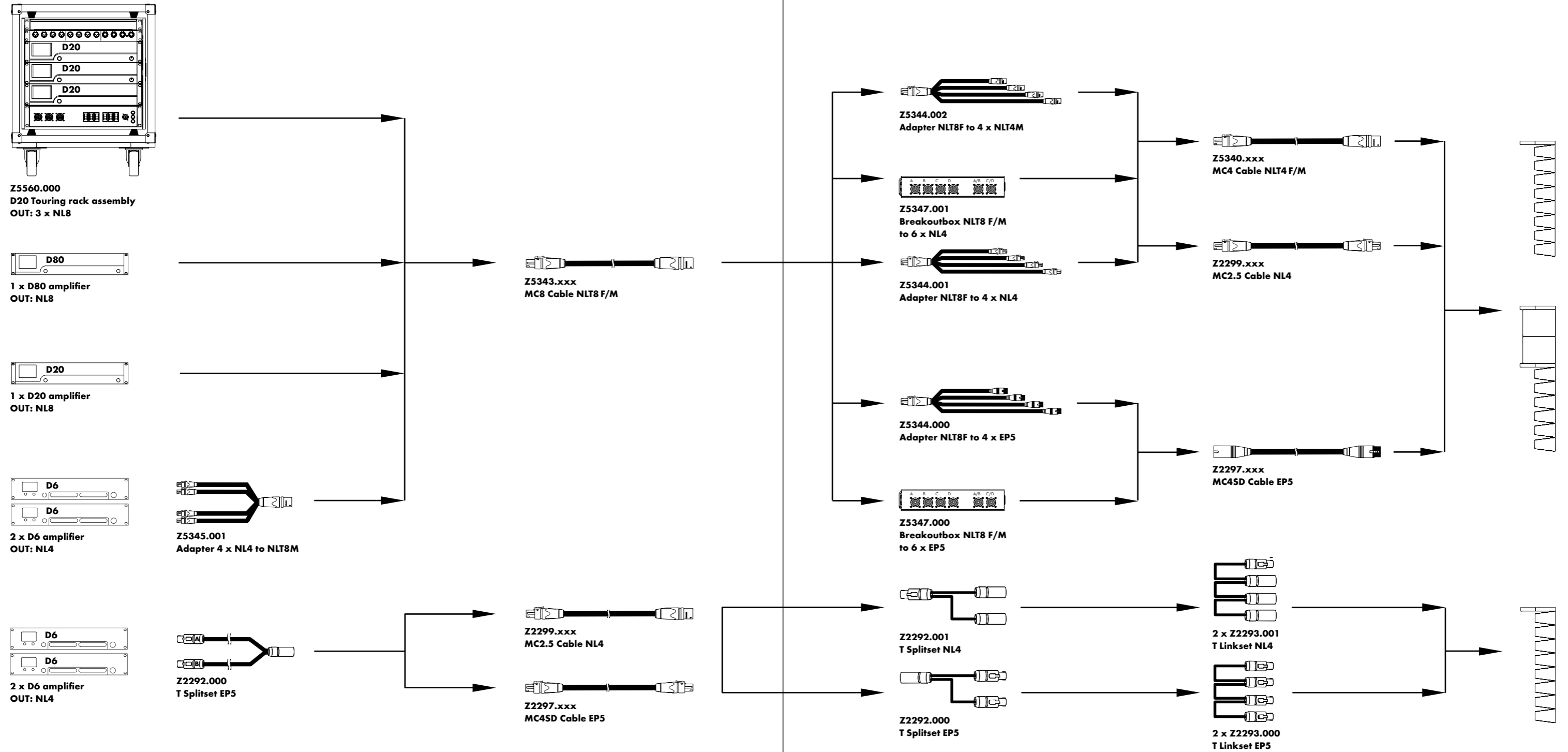

# The T-Series configuration examples

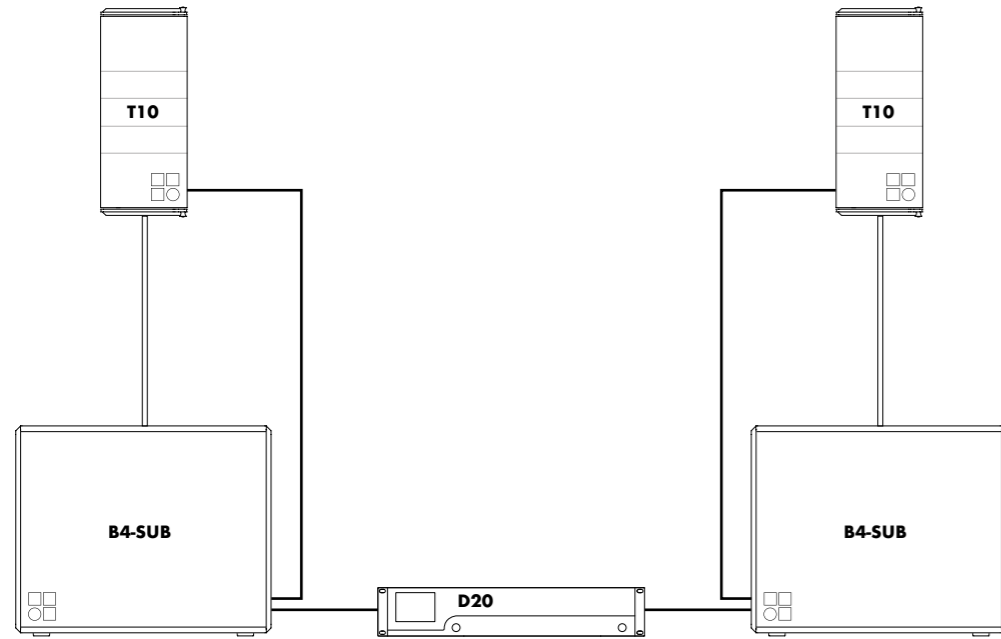

T10 loudspeakers in point source orientation on B4-SUBs with a D20 amplifier in Mix TOP/SUB mode<sup>1</sup>

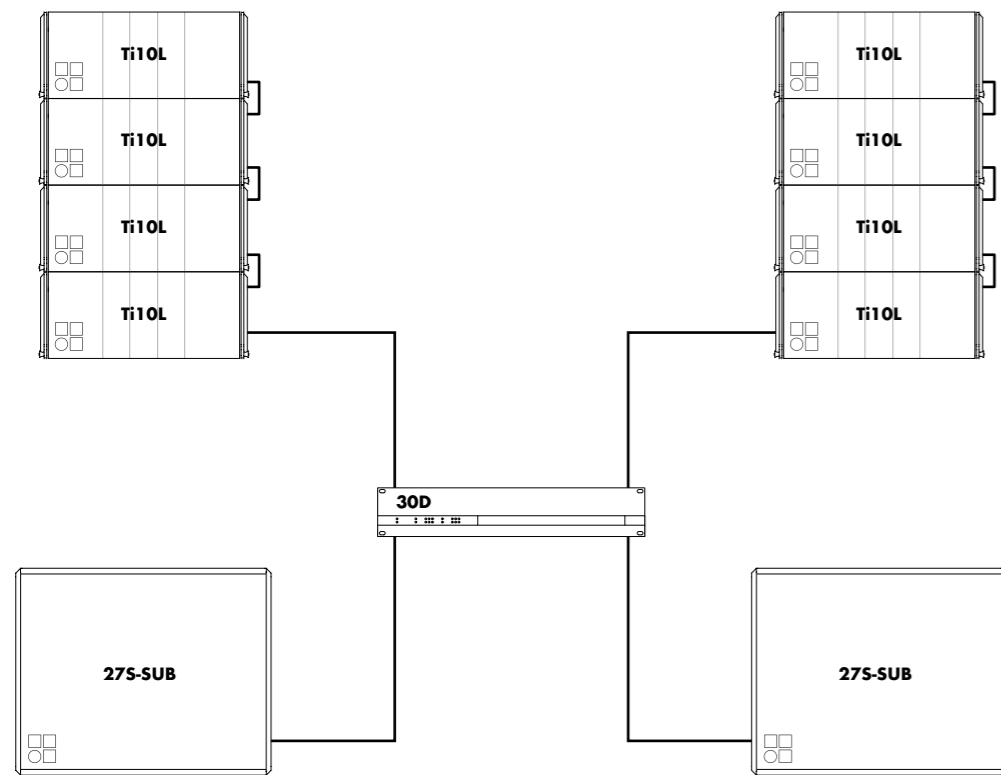

Ti10L line array on 275-SUBs with a 30D amplifier in Dual Channel mode

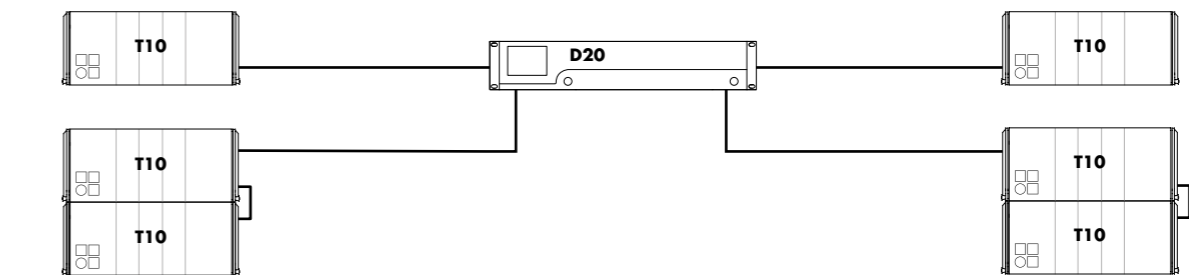
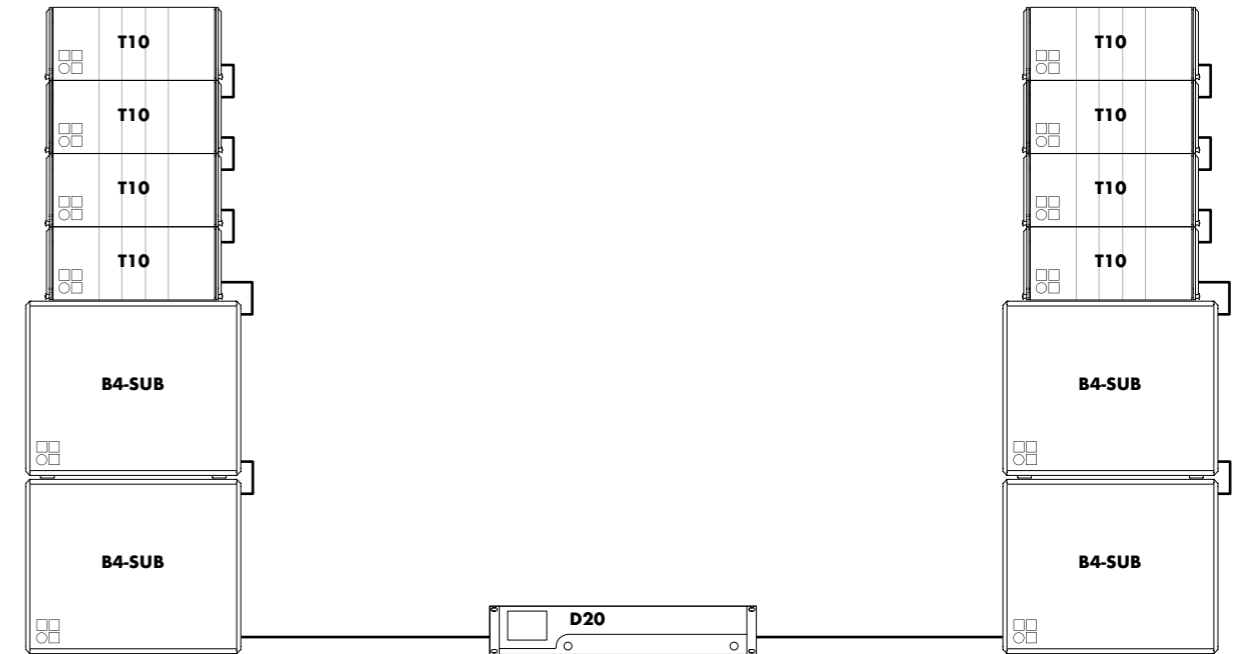

T10 line array on B4-SUBs ground stacked in left/right configuration with D20 amplifier in Mix TOP/SUB mode and T10s as frontfill and delay with D20 amplifier in Dual Channel mode



# The T-Series configuration examples

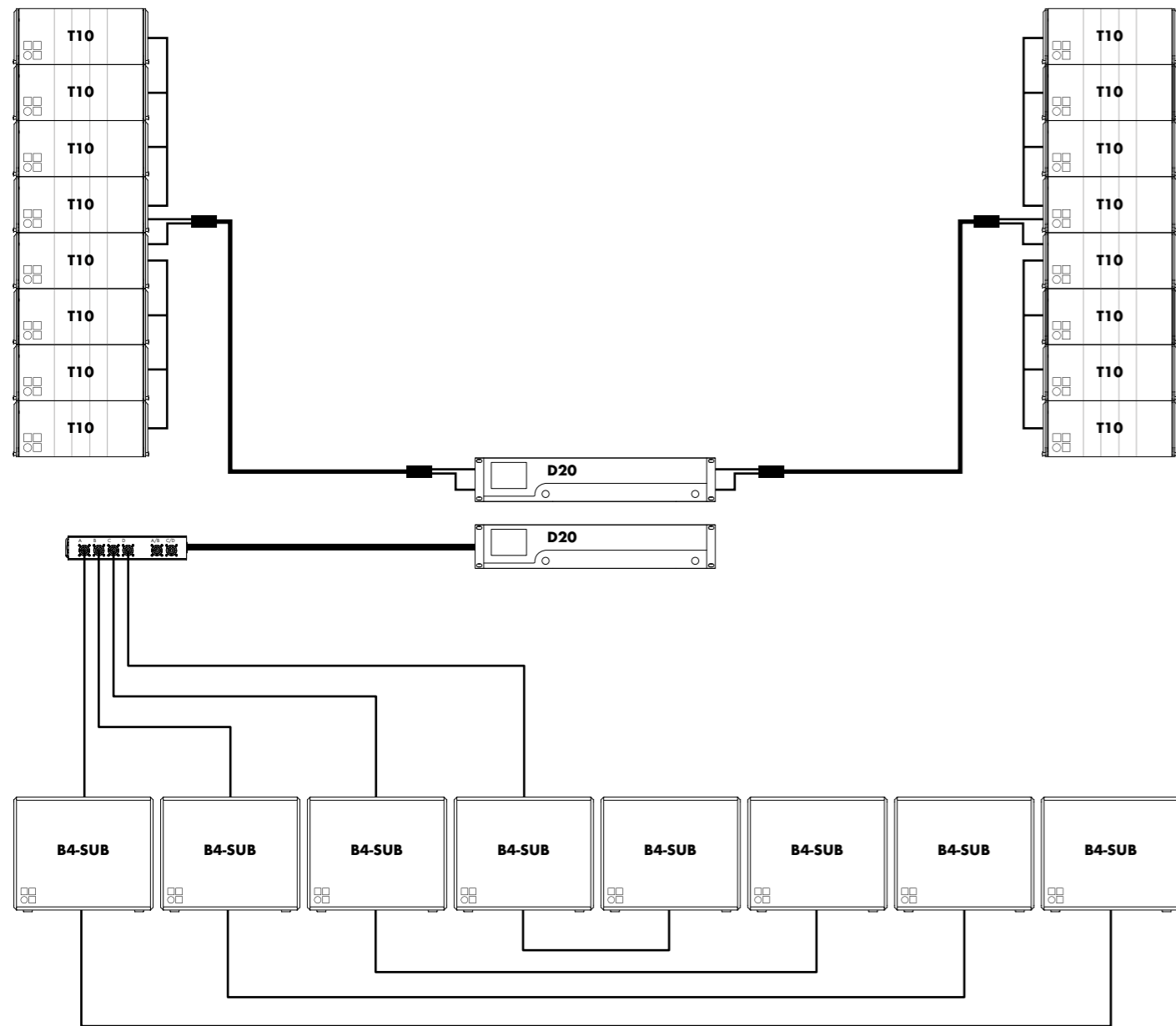

T10 flow line arrays in left/right configuration and ground stacked B4-SUB array with D20 amplifiers in Dual Channel mode<sup>1</sup>

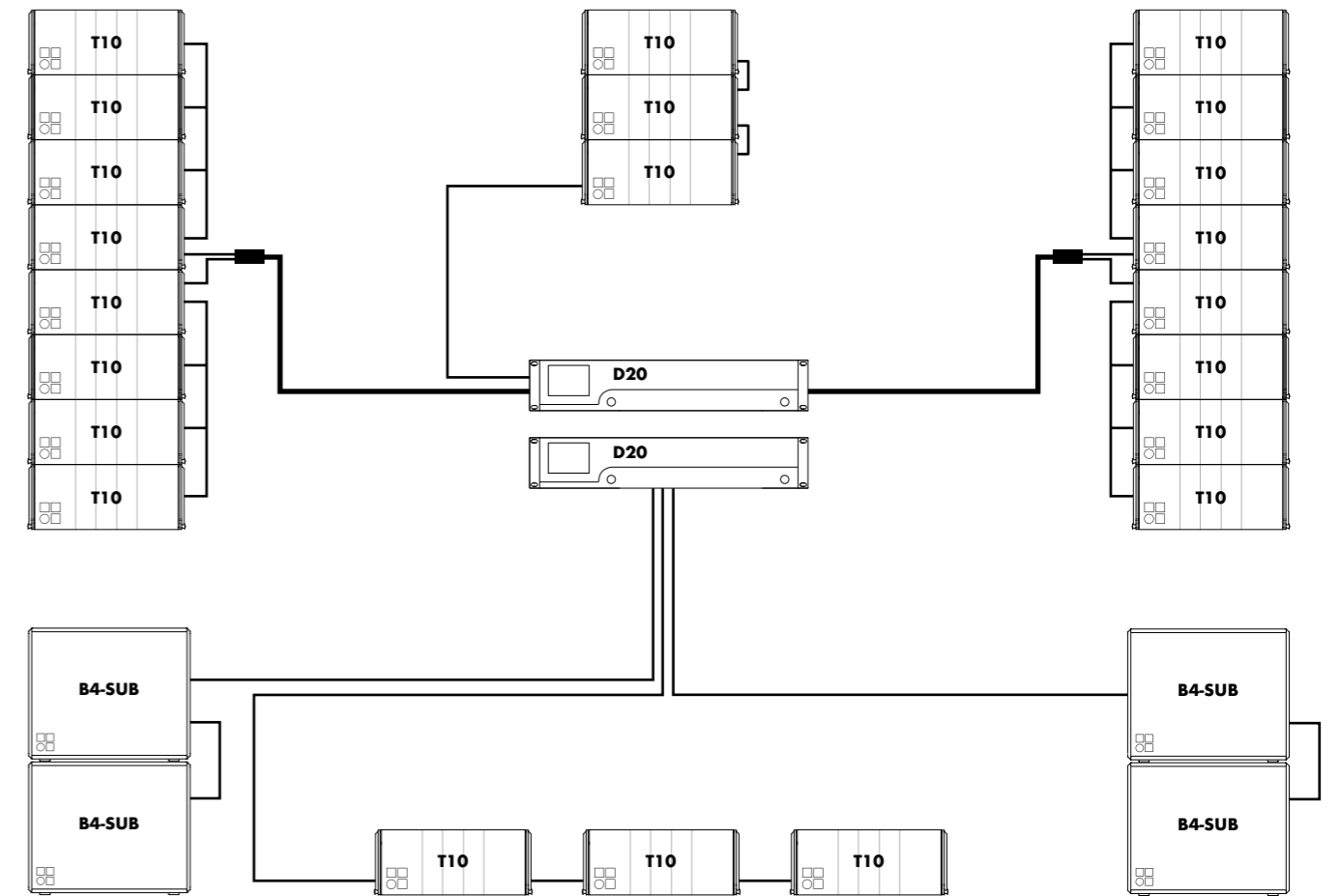

T10 flow line arrays in left/right configuration and centre cluster with T10 frontfills and ground stacked B4-SUBs on D20 amplifiers in Dual Channel mode<sup>1</sup>

# The T-Series product overview

<b>T loudspeakers</b>	Z0550.xxx Z0560.xxx Z0610.xxx	<b>T10 Loudspeaker</b> <b>T Subwoofer</b> <b>B4 Subwoofer</b>
<b>Loudspeaker connector options</b>	Zxxxx.000 Zxxxx.001 Zxxxx.002	<b>EP5</b> connector <b>NL4</b> connector <b>NLT4 F/M</b> connector
<b>Ti loudspeakers</b>	Z0551.001 Z0552.001 Z0561.001	<b>Ti10L Loudspeaker NL4</b> connector <b>Ti10P Loudspeaker NL4</b> connector <b>Ti Subwoofer NL4</b> connector <b>WR Weather Resistant option</b> <sup>1</sup> <b>SC Special Colour option</b> <sup>2</sup>
<b>Loudspeaker cases</b>	E7451.000 E7452.000 E7453.000 E7455.000	<b>Touring case 4 x T10</b> sleeve, wheels <b>Touring case 2 x T10</b> lid <b>Touring case 2 x T-SUB</b> sleeve, wheels <b>Touring case 2 x T Flying frame</b> lid, wheels
<b>Lid</b>	E7922.000	<b>B4-SUB Wooden lid</b>
<b>Accessories</b>	Z5370.000 Z5374.000 Z5371.000 Z5372.000 Z5373.000 Z5354.000 Z5355.000 Z5010.000 Z5015.000 Z5029.000 Z5009.000 Z5013.000 Z5024.000 Z5034.000 Z5012.500 Z5147.001 Z5155.000 E6507.000 Z5375.000	<b>T Flying frame</b> <sup>2</sup> <b>Ti Flying bar</b> <sup>2</sup> <b>T Flying bracket</b> <sup>2</sup> <b>T Horizontal bracket</b> <sup>2</sup> <b>T Cluster bracket</b> 3 deep <sup>2</sup> <b>E8/E12 Flying adapter</b> <sup>2</sup> <b>E8/E12 Flying adapter link</b> <b>TV spigot with fixing plate</b> <b>TV spigot for Flying adapter 02</b> <b>TV spigot M10</b> <b>Loudspeaker stand with winder</b> <b>Loudspeaker stand winder M20</b> <b>Loudspeaker stand adapter</b> <b>Stand adapter M10</b> <b>Pipe clamp</b> for TV spigot <b>Rota clamp</b> <b>Q Hoist connector chain</b> <b>1t Shackle</b> <b>T Base plate</b> <sup>3</sup>
<b>Remote network</b>	Z3010.000 Z6118.000 Z6124.000 Z6116.000 Z6122.000 Z6123.000	<b>R1 Remote control software</b> <sup>4</sup> <b>R60 USB to CAN interface</b> <b>R70 Ethernet to CAN interface</b> <b>RJ 45 M Terminator</b> <b>Bopla mounting clamp</b> <b>Bopla mounting clamp upright</b>

<sup>1</sup> WR only for Ti loudspeakers, on request  
<sup>2</sup> SC only for Ti loudspeakers, on request  
<sup>3</sup> For T10 only  
<sup>4</sup> Available as a download at [www.dbaudio.com](http://www.dbaudio.com)

<b>Amplifiers</b>	Z2750.xxx Z2770.xxx Z2760.xxx Z2700.xxx Z2710.xxx	<b>D20 Amplifier</b> <sup>5</sup> <b>30D Amplifier</b> <sup>6</sup> <b>10D Amplifier</b> <sup>6</sup> <b>D6 Amplifier</b> <sup>5</sup> <b>D80 Amplifier</b> <sup>5</sup>
<b>Audio networking</b>	Z4010.000 Z5563.000 Z5339.000	<b>DS10 Audio network bridge</b> <b>DS10 Rack upgrade kit</b> <b>Multichannel extension cable</b>
<b>Amplifier rack assemblies</b>	Z5560.000 Z5561.000 Z5330.001 Z5562.001 Z5330.xxx	<b>D20 Touring rack assembly CEE 32A 5P, NL4</b> <sup>7</sup> <b>D20 Touring rack assembly CEE 32A 5P, NL4, DS10</b> <sup>7</sup> <b>D80 Touring rack assembly, CEE 32A 5P, NL4</b> <sup>7</sup> <b>D80 Touring rack assembly, CEE 32 A 5P, NL4, DS10</b> <sup>7</sup> <b>D80 Touring rack assembly, Nema L21-30 (120V devices) on request</b> <sup>7</sup>
<b>Amplifier racks</b>	E7480.000 E7468.000	<b>D20 Touring rack 2 RU 19"</b> SD, shock mounted, handles <b>D80 Touring rack 2 RU, 19"</b> SD, shock mounted, handles
<b>Cables</b>	Z5343.xxx Z5346.000 Z5345.001 Z5344.002 Z5344.001 Z5344.000 Z5347.001 Z5347.000 Z5340.xxx Z2299.xxx Z2297.xxx Z2298.xxx Z2293.002 Z2293.001 Z2293.000 Z2292.002 Z2292.001 Z2292.000	<b>MC8 Cable NLT8 F/M</b> <b>Adapter 4 x EP5M to NLT8M</b> <b>Adapter 4 x NL4 to NLT8M</b> <b>Adapter NLT8F to 4 x NLT4M</b> <b>Adapter NLT8F to 4 x NL4</b> <b>Adapter NLT8F to 4 x EP5</b> <b>Breakoutbox NLT8 F/M to 6 x NL4</b> <b>Breakoutbox NLT8 F/M to 6 x EP5</b> <b>MC4 Cable NLT4 F/M</b> <b>MC2.5 Cable NL4</b> <b>MC4SD Cable EP5</b> <b>MC2.5SD Cable EP5</b> <b>T Linkset NLT4 F/M</b> <b>T Linkset NL4</b> <b>T Linkset EP5</b> <b>T Splitset NLT4 F/M</b> <b>T Splitset NL4</b> <b>T Splitset EP5</b>
<b>Misc.</b>	Z5061.000	<b>Standard cabinet paint 1 kg/2.2 lb</b>

<sup>5</sup> The complete list of mobile amplifier versions is available in the D Amplifier and Software brochure  
<sup>6</sup> The complete list of installation amplifier versions is available in the xD Installation Amplifier and Software brochure  
<sup>7</sup> Further information is available in the D Amplifier and Software brochure

