

E

E-Series

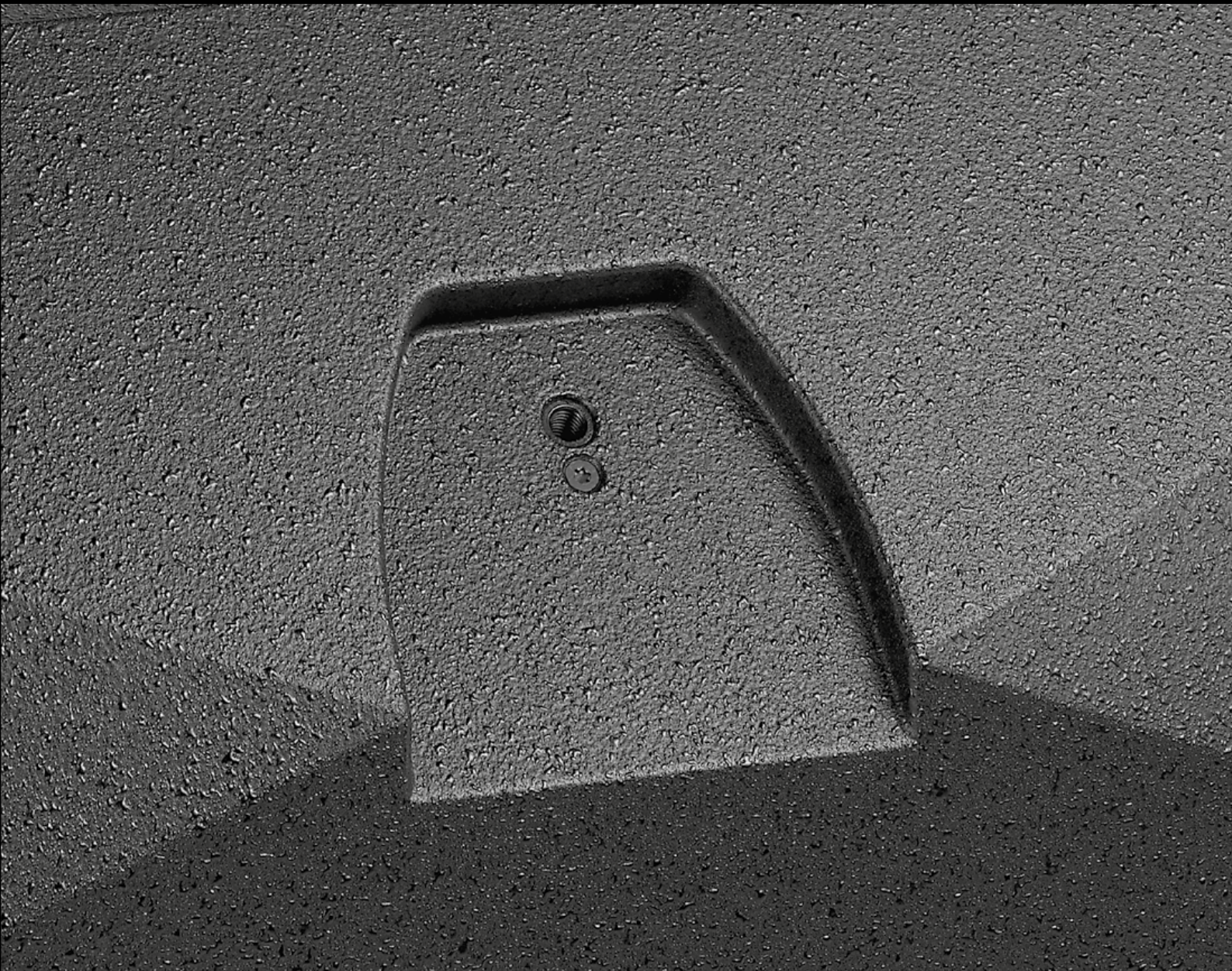

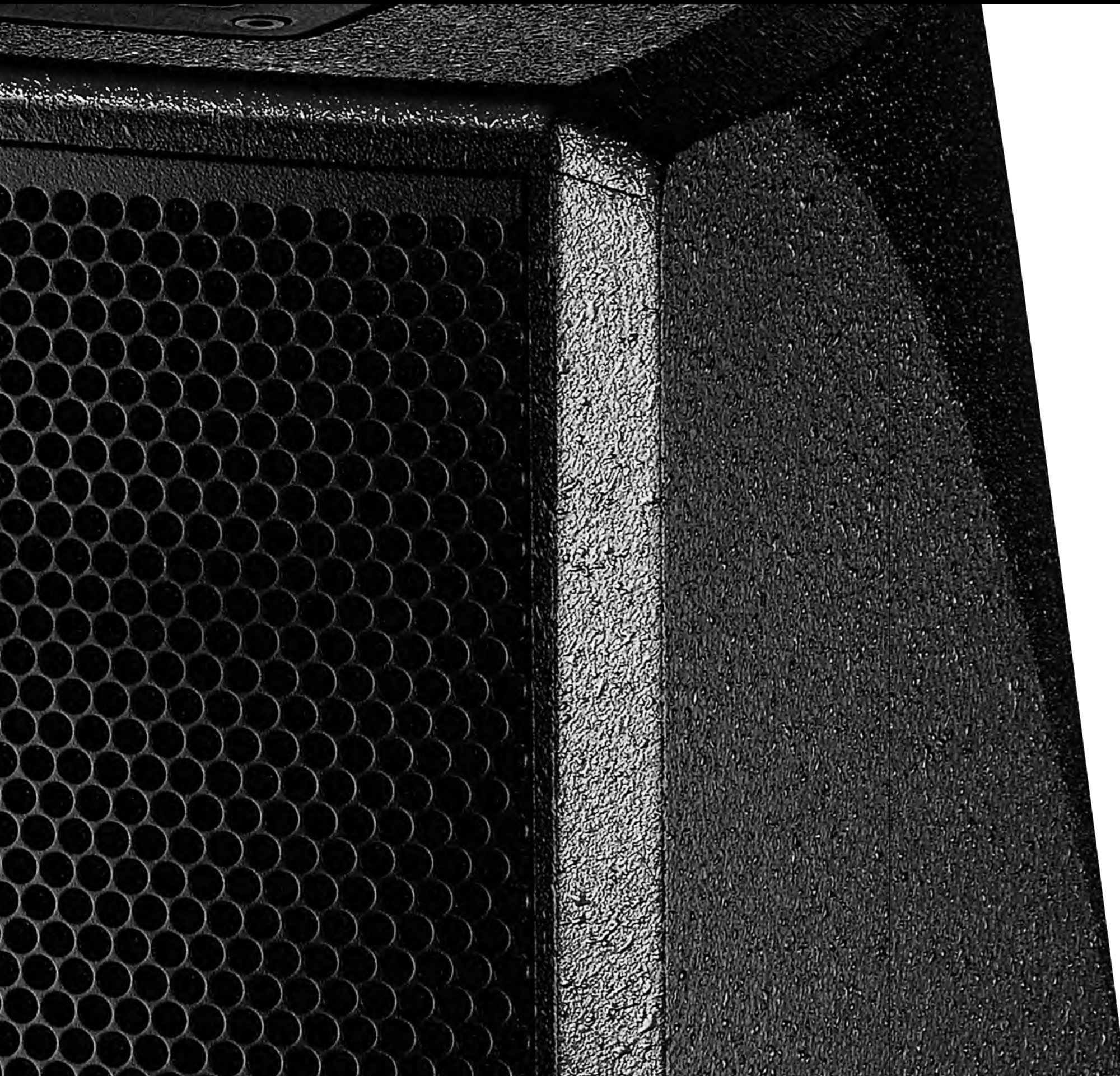

The d&b System reality	4
The E-Series	6
The E4 loudspeaker	10
The E5 loudspeaker	11
The E6 loudspeaker	12
The E8 loudspeaker	13
The E12/E12-D loudspeakers	14
The E12X subwoofer	15
The E15X subwoofer	16
The B4 subwoofer	17
The E4/E5 mounting accessories	18
The E4/E5 mounting examples	19
The E6 mounting accessories	20
The E6 mounting examples	21
The E8/E12 mounting accessories	22
The E8/E12 mounting examples	23
The E-Series Weather Resistant and Special Colour options	24
The E4 and E5 cases	25
The d&b ArrayCalc simulation software	26
The d&b NoizCalc immission modelling software	26
The d&b R1 Remote control software	27
The d&b amplifiers	28
The operation with d&b amplifiers	30
The E-Series frequency responses	32
The d&b amplifier output modes	33
The DS10 Audio network bridge	34
The E-Series configuration examples	35
The E-Series cables and adapters	36
The E-Series product overview	38

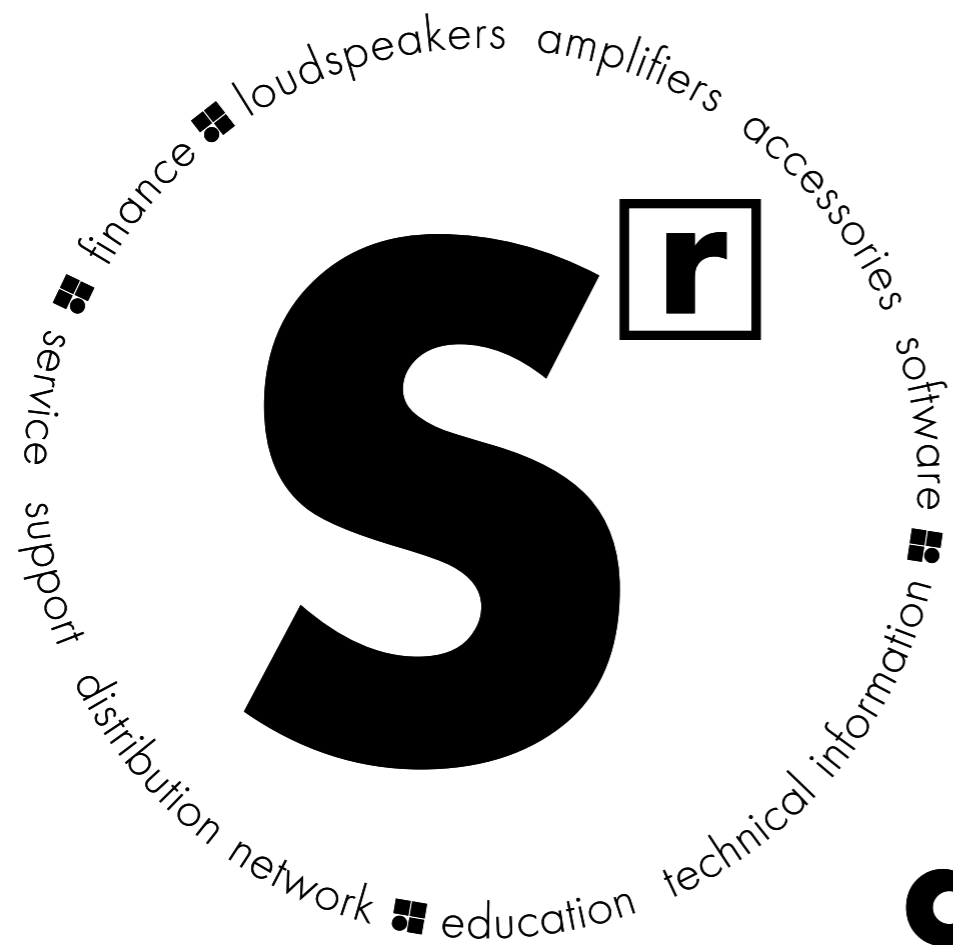

d&b System reality

As the name implies a d&b audiotechnik system is not just a loudspeaker. Nor is it merely a sum of the components: loudspeakers, amplifiers, accessories and software. Right from the outset the d&b audiotechnik approach was to build integrated sound reinforcement systems that actually are

more than the combination of parts: an entirety where each fits all. Every element is tightly specified, precisely aligned and carefully matched to achieve maximum efficiency. For ease of use, all the user-definable parameters are incorporated, allowing the possibility of adjustment, either via remote control surfaces

or directly on the amplifiers. Neutral sound characteristics leave the user all the freedom needed to realize whatever the brief. At the same time d&b offers finance, service and support, a knowledgeable distribution network, education and training as well as technical information, so the same optimal acoustic result

is achieved consistently by every system anywhere, at any time. In reality: the d&b System reality.



The complete **E-Series** is a range of five small to medium sized point source loudspeakers of a multifaceted moulded construction to achieve the maximum deployment versatility. They utilize direct radiating low frequency elements with coaxially mounted high frequency sections. Three direct radiating subwoofers compliment

the E-Series loudspeakers. The compact and unobtrusive design makes these loudspeakers visually discreet, yet a combination of accurate directivity control, extended bass response and appropriate sound pressure levels, make them audibly impressive for such small loudspeakers. A distinctive aspect of the coaxial

design is the accurate directivity control it provides, particularly in the critical midrange that is so vital for voice reproduction. The design incorporates all the necessary fittings into small, lightweight enclosures, making the loudspeakers quick and easy to handle. The E-Series is predominantly used in theatres,

conferences, industrial presentations, broadcast studios and as surround sound, delay and fill systems. They are intended for both mobile and installation applications, can be colour matched to interior designs and can be weather protected for climatically hostile environments.

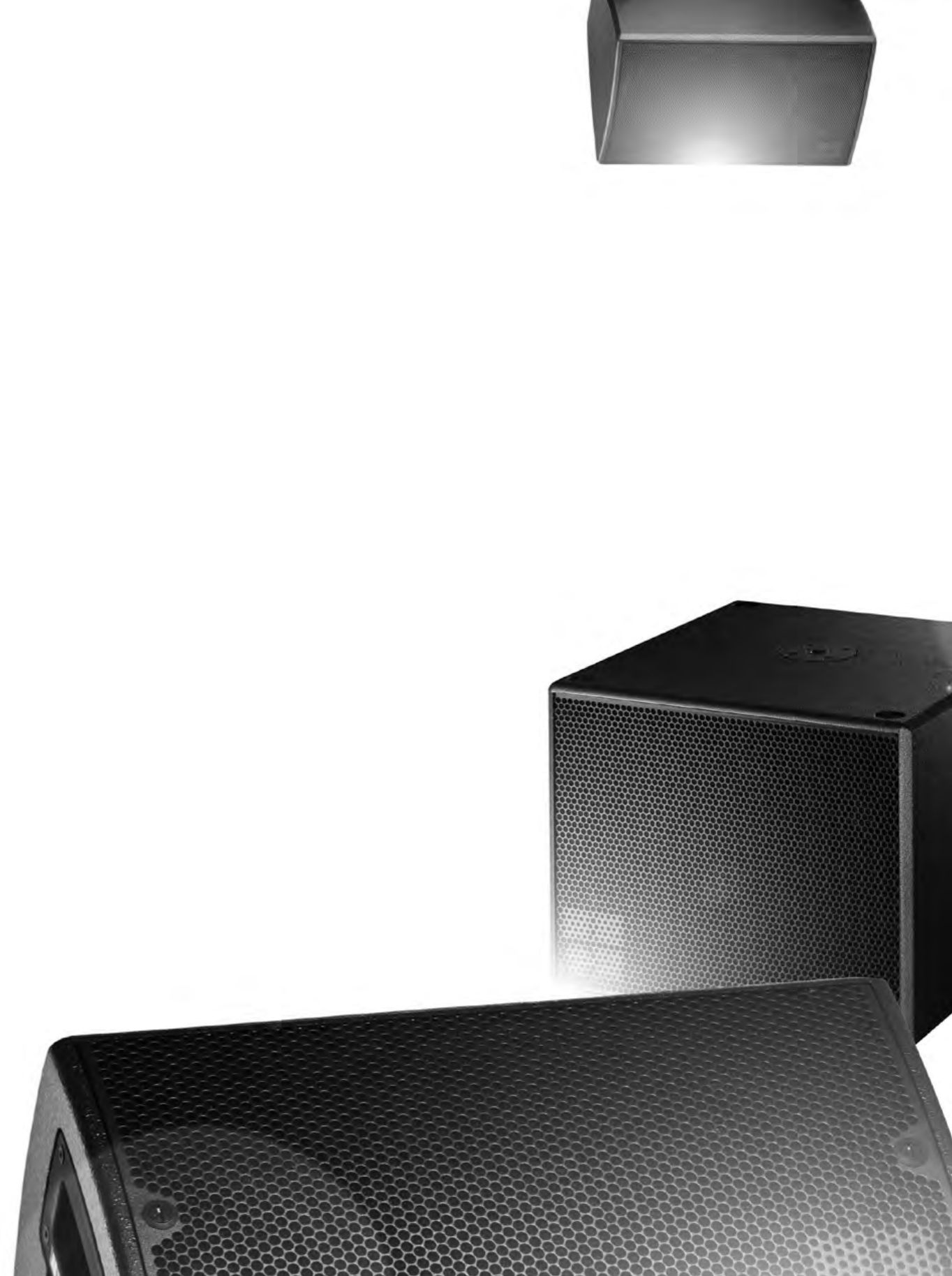

The E-Series

The **E4** and **E5** are the littlest loudspeakers in the E-Series which are specifically suited for near field applications featuring 4" or 5" LF drivers respectively and a coaxially mounted HF dome tweeter. They produce a wide symmetrical directivity up to very high frequencies.

The **E6**, larger **E8** and even larger **E12/E12-D** are high performance multipurpose loudspeakers utilizing a patented coaxial horn assembly that can be rotated without the need for any special tools permitting changes to the dispersion angle enabling deployment of these loudspeakers either vertically or horizontally. The E6 and E8 employ a 6.5" and 8" coaxial driver respectively with an HF compression driver mounted on the unique rotatable horn assembly. Compared to the E4 and E5, the slightly larger E6 has a greater SPL to size ratio yet still provides a very compact reinforcement solution that inspires through its sound quality and is also perfectly compatible with the larger E8 and E12. The E8's sound pressure level capabilities when coupled with a subwoofer can realize ambitious application possibilities. The E12 shares the same physical, acoustical and mechanical design elements as the smaller E8. The larger cabinet volume and a 12" LF driver provide a warm and full low frequency extension and higher power capabilities. All other aspects of the loudspeaker are quite simply scaled, allowing exactly the same broad range of application possibilities. The E12-D is a wider dispersion version of the E12 loudspeaker.

The **E12X-SUB** and **E15X-SUB** are lightweight, low profile, bass-reflex subwoofers utilizing 12" and 15" long excursion drivers respectively. They can be operated in two modes, an active mode with a dedicated amplifier configuration, or passively using the internal crossover connected in parallel with either an E8 loudspeaker for the E12X-SUB or an E12 loudspeaker for the E15X-SUB driven from a single amplifier channel.

The **B4-SUB** is a compact high performance cardioid subwoofer utilizing two long excursion neodymium drivers in an integrated cardioid setup to avoid unwanted energy behind the system. This passive cardioid design can be operated from a single amplifier channel.



The d&b software offering aides the entire system setup process, from the simulation and planning of the loudspeaker systems, to the remote control and monitoring of the system functions during the event, followed by service functionality to verify system performance prior to de-rigging. The **ArrayCalc** simulation software allows the virtual optimization of loudspeaker line arrays, point source and column loudspeakers as well as subwoofers and their adjustment to venue conditions. The d&b **NoizCalc** software uses international standards to model noise immission from one or more d&b loudspeaker systems. NoizCalc takes data from ArrayCalc and calculates the sound propagation and relative attenuation values towards the far field. The complete system configuration simulated in ArrayCalc is assimilated by the **R1** Remote control software into an intuitive graphical user interface to manage the amplifiers, and loudspeakers, from anywhere in the venue. Service functions enable firmware updates of the amplifiers as and when these are available.

d&b amplifiers are specifically designed for use with d&b loudspeakers, and are at the heart of the d&b system approach. These devices contain extensive Digital Signal Processing capabilities to provide comprehensive loudspeaker management and specific switchable filter functions to precisely target the system response for a wide variety of applications. The four channel **D20** amplifier is specifically designed for mobile events comprising medium sized sound reinforcement solutions. The **10D** and **30D** amplifiers both provide four channels and are intended for integration within permanent installations. The 10D is designed to drive smaller d&b loudspeakers and applications requiring lower Sound Pressure Levels whereas the high powered 30D is intended to drive all d&b loudspeakers at medium to high SPLs. The dual channel **D6** amplifier is designed to provide low Sound Pressure Levels in either mobile or installed applications. These amplifiers all provide extensive user-definable equalization and delay capabilities to fine tune the system for artistic taste.

The **DS10** Audio network bridge provides 16 AES3 outputs and interfaces between the Dante audio transport protocol and the d&b amplifiers.

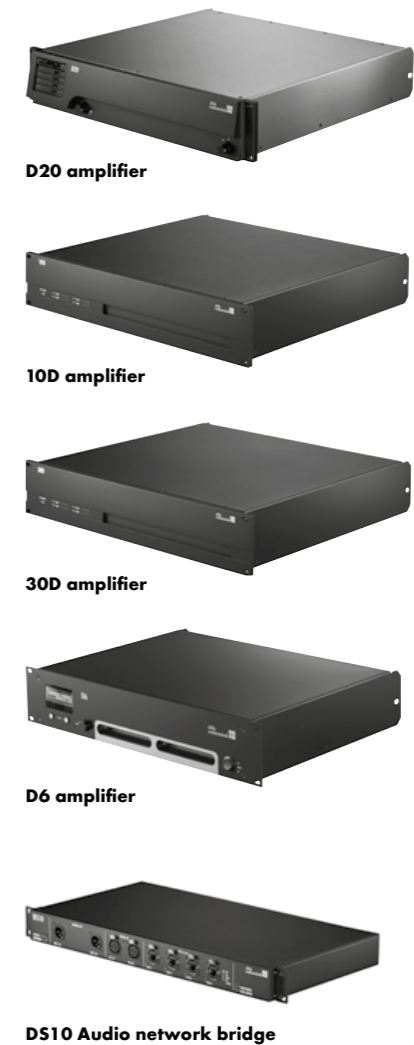

The E4 loudspeaker

E4 loudspeaker

The E4 is a lightweight 2-way passive loudspeaker using a neodymium LF driver and a coaxially mounted wide dispersion dome tweeter. The E4's coaxial design employs a 4" driver in a highly compact sealed enclosure and offers a wide symmetrical dispersion pattern in the horizontal and vertical plane while the cabinet may be mounted in either attitude.

It can be used stand-alone or supplemented by different subwoofers from the E-Series.

The enclosure is injection moulded with an impact resistant paint finish. The front of the loudspeaker cabinet is protected by a rigid metal grill and incorporated into the rear panel is an M10 threaded insert to accept the Ball joint adapter.

System data

Frequency response (-5 dB standard) 130 Hz - 20 kHz
 Frequency response (-5 dB CUT mode)..... 180 Hz - 20 kHz
 Max. sound pressure (1 m, free field)¹
 with D6/10D 114 dB
 with D20/30D 115 dB
 with D80 115 dB
 Input level (100 dB SPL/1 m) -4 dBu

Loudspeaker data

Nominal impedance 16 ohms
 Power handling capacity (RMS/peak 10 msec)60/400 W
 Nominal dispersion angle 100° conical
 Components 4" driver with neodymium magnet
 0.75" dome tweeter coaxially mounted
 passive crossover network
 Connections 2 x NL4
 1 x two pole push terminal
 Weight 1.1 kg (2.4 lb)

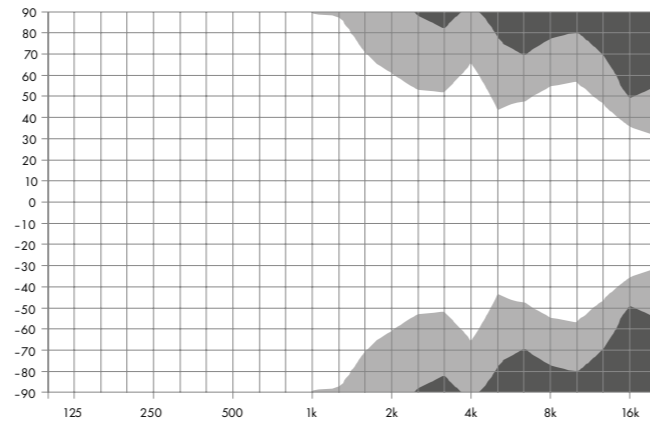

E4 horizontal dispersion characteristics²

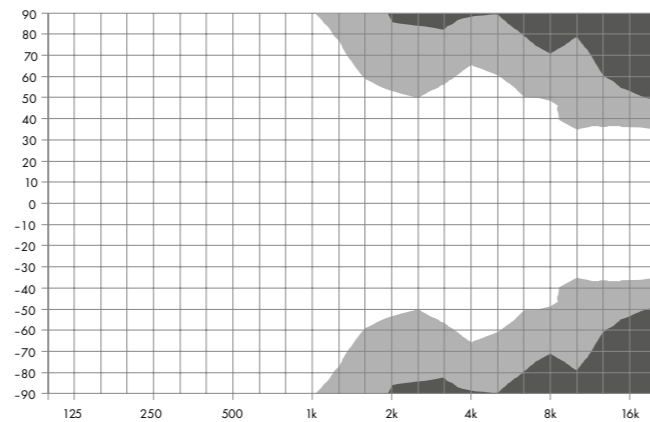

E4 vertical dispersion characteristics²

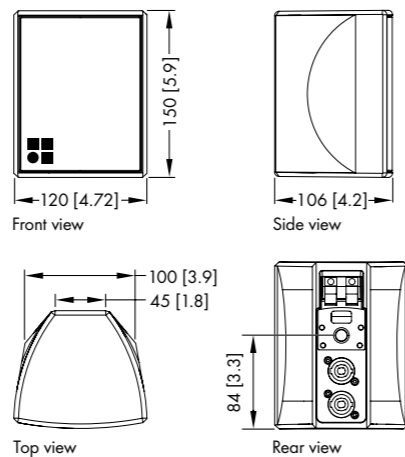

E4 cabinet dimensions in mm [inch]

¹ Broadband measurement, pink noise, crest factor 4, peak measurement, linear weighting
² Dispersion angle vs frequency plotted using lines of equal sound pressure (isobars) at -6 dB and -12 dB

The E5 loudspeaker

E5 loudspeaker

The E5 is a lightweight 2-way passive loudspeaker using a ferrite LF driver and a coaxially mounted wide dispersion dome tweeter. The E5's coaxial design employs a 5" driver in a compact bass-reflex enclosure and offers a wide symmetrical dispersion pattern in the horizontal and vertical plane while the cabinet may be mounted in either attitude.

It can be used stand-alone or supplemented by different subwoofers from the E-Series.

The enclosure is injection moulded with an impact resistant paint finish. The front of the loudspeaker cabinet is protected by a rigid metal grill and incorporated into the rear panel is an M10 threaded insert to accept the Ball joint adapter.

System data

Frequency response (-5 dB standard) 85 Hz - 20 kHz
 Frequency response (-5 dB CUT mode)..... 130 Hz - 20 kHz
 Max. sound pressure (1 m, free field)¹
 with D6/10D 116 dB
 with D20/30D 117 dB
 with D80 117 dB
 Input level (100 dB SPL/1 m) -6 dBu

Loudspeaker data

Nominal impedance 16 ohms
 Power handling capacity (RMS/peak 10 msec)60/400 W
 Nominal dispersion angle 100° conical
 Components 5" driver with ferrite magnet
 1" dome tweeter coaxially mounted
 passive crossover network
 Connections 2 x NL4
 1 x two pole push terminal
 Weight 2.7 kg (6.0 lb)

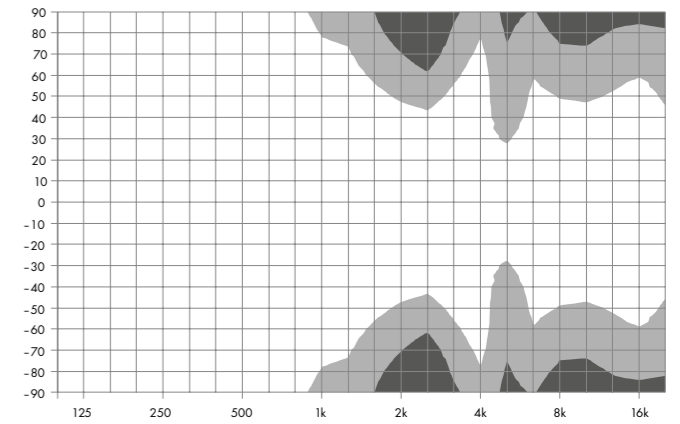

E5 horizontal dispersion characteristics²

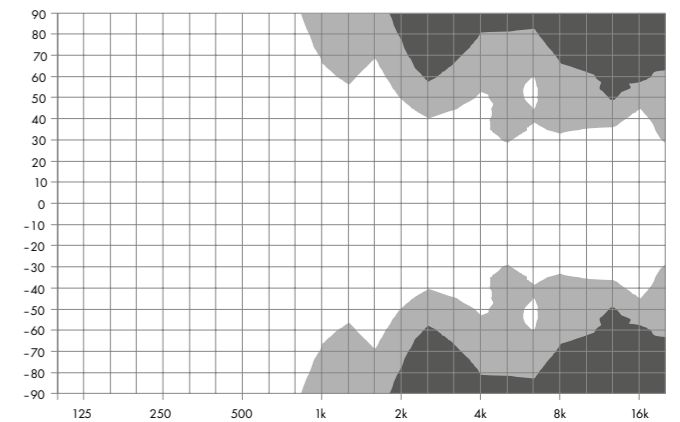

E5 vertical dispersion characteristics²

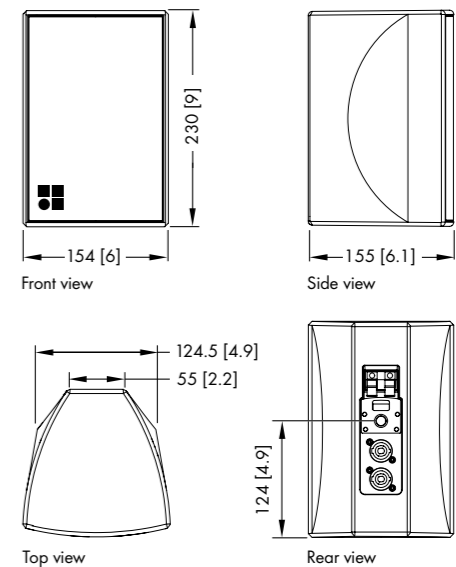

E5 cabinet dimensions in mm [inch]

¹ Broadband measurement, pink noise, crest factor 4, peak measurement, linear weighting
² Dispersion angle vs frequency plotted using lines of equal sound pressure (isobars) at -6 dB and -12 dB

The E6 loudspeaker

E6 loudspeaker

The E6 is a high performance 2-way multipurpose loudspeaker employing an integrated coaxial driver with a neodymium magnet assembly. The 1" exit HF compression driver and constant directivity horn are accommodated within the circumference of the 6.5" LF driver. The horn with its 100° x 55° dispersion pattern (h x v) can easily be rotated through 90° without the use of tools to provide a 55° x 100° dispersion pattern.

The E6 can be used for speech and music applications as a stand-alone full range system, or incorporated into larger distributed sound reinforcement situations. It can be mounted on loudspeaker stands or flown from overhead bars, while the multifaceted shape of the enclosure allows use either in a vertical or horizontal orientation as well as deployment as a stage monitor. With the addition of an E12X-SUB or any other E-Series subwoofer, the E6 can also reproduce high level music program. The E6 cabinet has an impact resistant paint finish. The front is protected by a magnetically attached rigid metal grill backed by an acoustically transparent fabric. The grill can easily be removed without tools to modify the horn orientation. The cabinet incorporates a handle.

System data

Frequency response (-5 dB standard).....85 Hz - 20 kHz
 Frequency response (-5 dB CUT mode) 120 Hz - 20 kHz
 Max. sound pressure (1 m, free field)¹
 with D6/10D..... 120 dB
 with D20/30D 123 dB
 with D80..... 123 dB
 Input level (100 dB SPL/1 m)..... -11 dBu

Loudspeaker data

Nominal impedance20 ohms
 Power handling capacity (RMS/peak 10 msec)..... 150/800 W
 Nominal dispersion angle (h x v) 100° x 55°
 rotatable through 55° x 100°
 Components 6.5" driver with neodymium magnet
1" exit compression driver with 1.75" coil and rotatable CD horn
passive crossover network
 Connections 2 x NLT4 F/M
 optional 2 x EP5 or 2 x NL4
 Weight5 kg (11 lb)

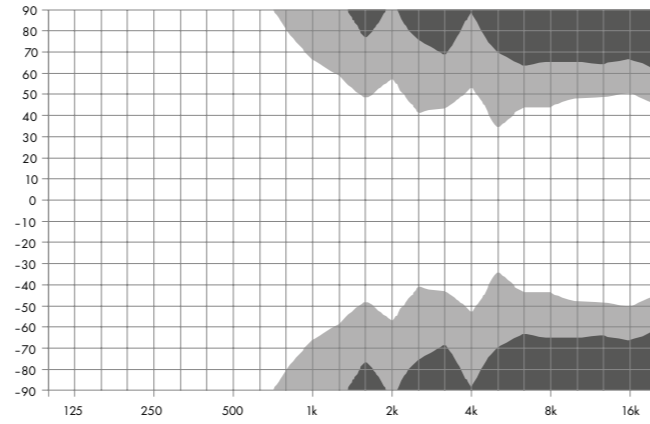

E6 horizontal dispersion characteristics²

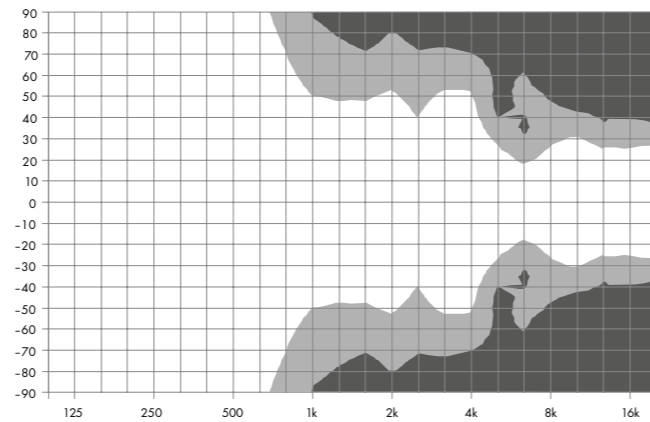

E6 vertical dispersion characteristics²

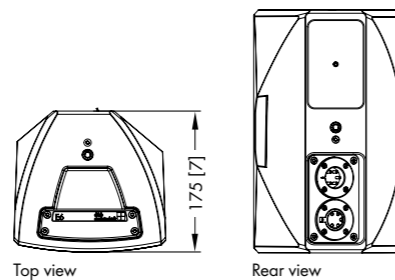
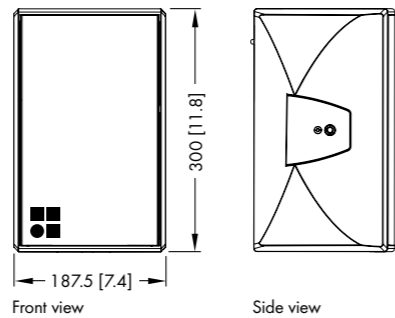

E6 cabinet dimensions in mm [inch]

¹ Broadband measurement, pink noise, crest factor 4, peak measurement, linear weighting
² Dispersion angle vs frequency plotted using lines of equal sound pressure (isobars) at -6 dB and -12 dB

The E8 loudspeaker

E8 loudspeaker

The E8 is a high performance 2-way multipurpose loudspeaker employing an integrated coaxial driver with a neodymium magnet assembly. The 1" exit HF compression driver and constant directivity horn are accommodated within the circumference of the 8" LF driver. With its 90° x 50° dispersion pattern (h x v), the horn is easily rotatable through 90° without the use of tools to provide a 50° x 90° dispersion pattern.

The E8 can be used for speech and music applications as a stand-alone full range system, or incorporated into larger distributed sound reinforcement situations. It can be mounted on loudspeaker stands or flown from overhead bars, while the multifaceted shape of the enclosure allows use either in a vertical or horizontal orientation as well as deployment as a stage monitor. With the addition of an E12X-SUB or any other E-Series subwoofer, the E8 can also reproduce high level music program.

The E8 cabinet is constructed from polyurethane integral hard foam with an impact resistant paint finish. The front of the loudspeaker cabinet is protected by a rigid metal grill backed by an acoustically transparent foam. The grill can easily be removed without tools to modify the horn orientation. The cabinet incorporates a handle and a socket to accept loudspeaker stands.

System data

Frequency response (-5 dB standard).....62 Hz - 18 kHz
 Frequency response (-5 dB CUT mode) 120 Hz - 18 kHz
 Max. sound pressure (1 m, free field)¹
 with D6/10D..... 126 dB
 with D20/30D 129 dB
 with D80..... 129 dB
 Input level (100 dB SPL/1 m)..... -13 dBu

Loudspeaker data

Nominal impedance16 ohms
 Power handling capacity (RMS/peak 10 msec)..... 150/800 W
 Nominal dispersion angle (h x v)90° x 50°
 rotatable through 50° x 90°
 Components8" driver with neodymium magnet
1" exit compression driver with 1.75" coil and rotatable CD horn
passive crossover network
 Connections 2 x NLT4 F/M
 optional 2 x EP5 or 2 x NL4
 Weight7.3 kg (16.1 lb)

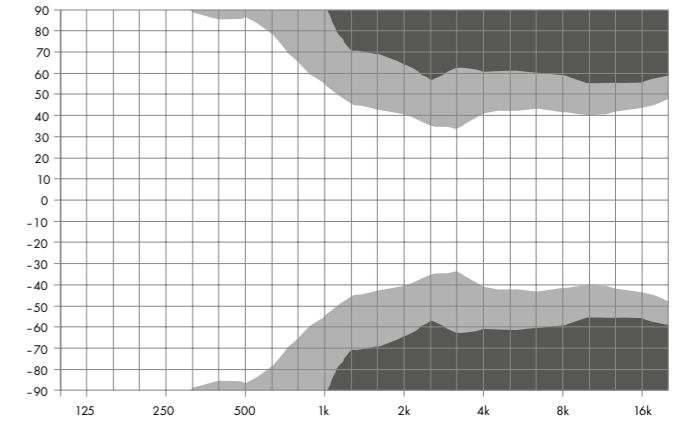

E8 horizontal dispersion characteristics²

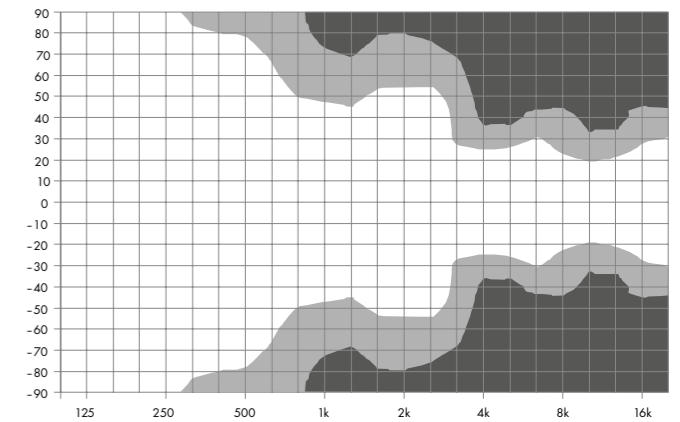

E8 vertical dispersion characteristics²

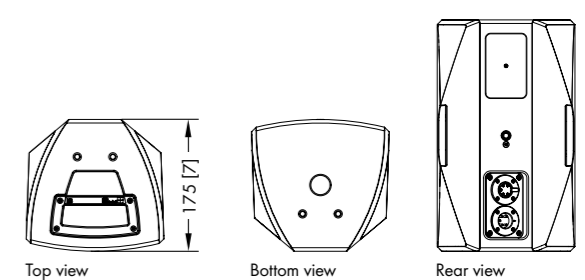
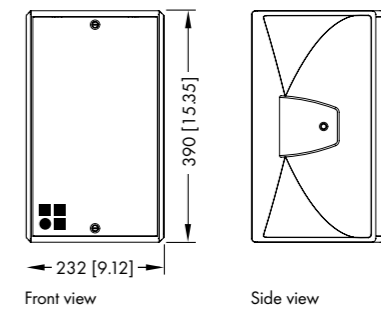

E8 cabinet dimensions in mm [inch]

¹ Broadband measurement, pink noise, crest factor 4, peak measurement, linear weighting
² Dispersion angle vs frequency plotted using lines of equal sound pressure (isobars) at -6 dB and -12 dB

The E12/E12-D loudspeakers

E12/E12-D loudspeakers

The E12 and E12-D are high performance 2-way multipurpose loudspeakers employing an integrated coaxial driver with a neodymium magnet assembly. The 1.3" exit HF compression driver and constant directivity horn are accommodated within the circumference of the 12" LF driver. The E12 has an 80° x 50° dispersion pattern (h x v), while the E12-D has a wider 110° x 50° pattern. The horns in both loudspeakers are easily rotatable through 90° without the use of tools, providing 50° x 80° or 50° x 110° dispersion patterns. The E12 and E12-D can be used for speech and music applications as a stand-alone full range system, or incorporated into larger distributed sound reinforcement situations. They can be mounted on loudspeaker stands or flown from overhead bars, while the multifaceted shape of the enclosure allows use either in a vertical or horizontal orientation as well as deployment as a stage monitor. With the addition of an E15X or B4 subwoofer, the E12 and E12-D loudspeakers can also easily reproduce high level music program.

The E12 and E12-D cabinets are constructed from polyurethane integral hard foam with an impact resistant paint finish. The front of each loudspeaker cabinet is protected by a rigid metal grill backed by an acoustically transparent foam. The grill can easily be removed without tools to modify the horn orientation. Both cabinets incorporate a pair of handles and a hidden socket to accept loudspeaker stands.

System data E12 • E12-D

Frequency response (-5 dB standard) 50 Hz - 18 kHz
 Frequency response (-5 dB CUT mode)..... 100 Hz - 18 kHz
 Max. sound pressure (1 m, free field)¹
 with D6/10D 131 • 130 dB
 with D20/30D..... 134 • 133 dB
 with D80 134 • 133 dB
 Input level (100 dB SPL/1 m)..... -17 dBu

Loudspeaker data E12/E12-D

Nominal impedance8 ohms
 Power handling capacity (RMS/peak 10 msec)300/1600 W
 Nominal dispersion angle (h x v).....80°/110° x 50°
 rotatable through 50° x 80°/110°
 Components..... 12" driver with neodymium magnet
 ... 1.3" exit compression driver with 3" coil and rotatable CD horn
 passive crossover network
 Connections2 x NLT4 F/M
 optional 2 x EP5 or 2 x NL4
 Weight..... 16 kg (35 lb)

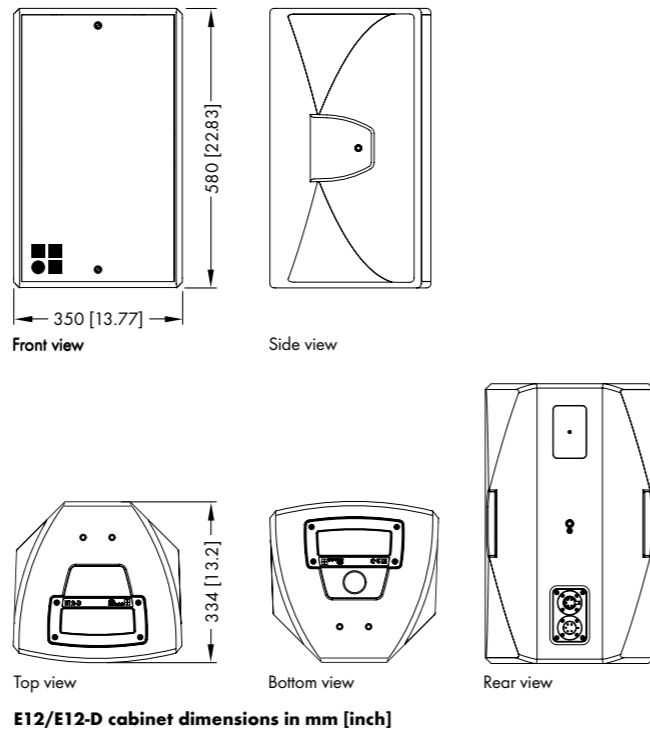
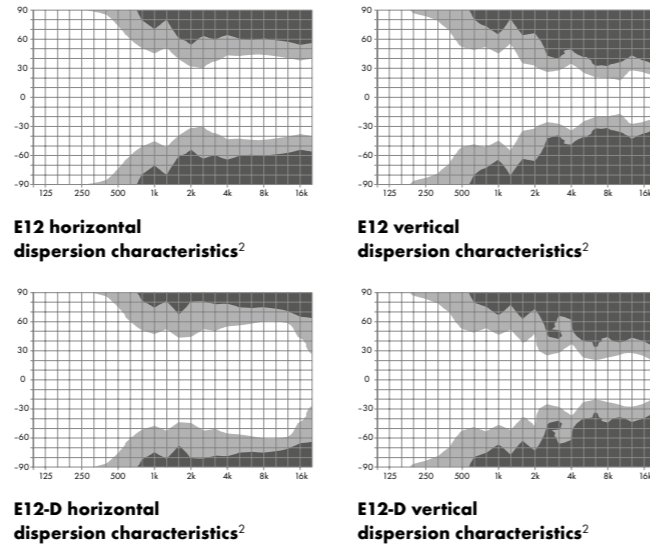

E12/E12-D cabinet dimensions in mm [inch]

¹ Broadband measurement, pink noise, crest factor 4, peak measurement, linear weighting
² Dispersion angle vs frequency plotted using lines of equal sound pressure (isobars) at -6 dB and -12 dB

The E12X subwoofer

E12X subwoofer

The E12X-SUB is a compact, light weight, high performance subwoofer for use with d&b E-Series loudspeakers. It employs a long excursion 12" neodymium driver in a bass-reflex enclosure. The built in passive crossover network allows the E12X-SUB to be connected in parallel to the E8 loudspeaker on the same amplifier channel, greatly extending the low frequency headroom and bandwidth of the systems. As an alternative it can be operated actively, driven by its own amplifier channel without the need for any changes to the cabinet. In active mode the E12X-SUB can be used to supplement any of the E-Series cabinets.

The E12X-SUB cabinet is constructed from marine plywood and has an impact resistant paint finish, a handle and an M20 threaded flange on the top to accept the d&b Loudspeaker stand winder M20. The front of the loudspeaker cabinet is protected by a rigid metal grill backed by an acoustically transparent foam. Four rubber feet prevent cabinet movement and protect the bottom panel against scratching. Correspondingly shaped recesses are incorporated in the top panel of each cabinet to accept these and to prevent cabinet movement when stacked.

System data

Frequency response (-5 dB standard)45 - 100 Hz
 Frequency response (-5 dB 140 Hz mode).....45 - 140 Hz
 Max. sound pressure (1 m, free field)¹
 with D6/10D 124 dB
 with D20/30D..... 127 dB
 with D80 127 dB

Loudspeaker data

Nominal impedance8 ohms
 Power handling capacity (RMS/peak 10 msec)300/1600 W
 Components 12" driver
 passive crossover network
 Connections2 x NLT4 F/M
 optional 2 x EP5 or 2 x NL4
 Weight..... 18 kg (40 lb)

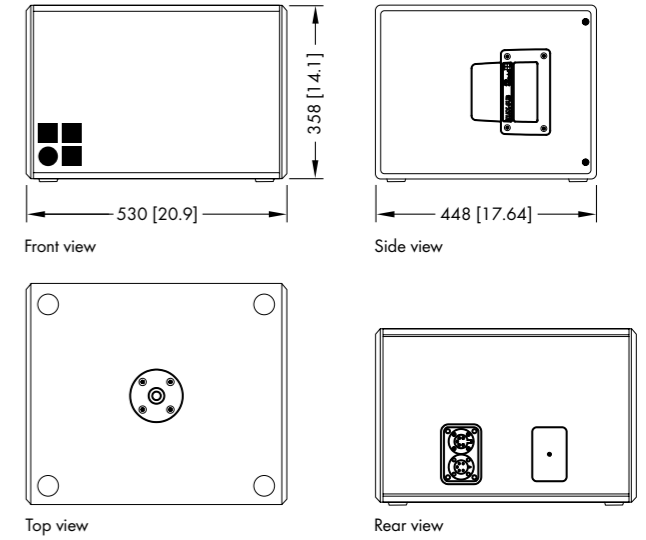

E12X-SUB cabinet dimensions in mm [inch]

¹ Broadband measurement, pink noise, crest factor 4, peak measurement, linear weighting

The E15X subwoofer

E15X subwoofer

The E15X-SUB is a compact, light weight, high performance subwoofer for use with d&b E-Series loudspeakers. It employs a long excursion 15" neodymium driver in a bass-reflex enclosure. The built in passive crossover network allows the E15X-SUB to be connected in parallel to E12 or E12-D loudspeakers on the same amplifier channel, greatly extending the low frequency headroom and bandwidth of the systems. As an alternative it can be operated actively, driven by its own amplifier channel without the need for any changes to the cabinet. In active mode the E15X-SUB can be used to supplement any of the E-Series cabinets. The E15X-SUB cabinet is constructed from marine plywood and has an impact resistant paint finish, a pair of handles and an M20 threaded flange on the top to accept the d&b Loudspeaker stand winder M20. The front of the loudspeaker cabinet is protected by a rigid metal grill backed by an acoustically transparent foam. Four rubber feet prevent cabinet movement and protect the bottom panel against scratching. Correspondingly shaped recesses are incorporated in the top panel of each cabinet to accept these and to prevent cabinet movement when stacked.

System data

Frequency response (-5 dB standard)37 - 140 Hz
 Frequency response (-5 dB 100 Hz mode).....37 - 100 Hz
 Max. sound pressure (1 m, free field)¹
 with D6/10D 127 dB
 with D20/30D 130 dB
 with D80 130 dB

Loudspeaker data

Nominal impedance8 ohms
 Power handling capacity (RMS/peak 10 msec)300/1600 W
 Components 15" driver
 passive crossover network
 Connections2 x NLT4 F/M
 optional 2 x EP5 or 2 x NL4
 Weight..... 24 kg (53 lb)

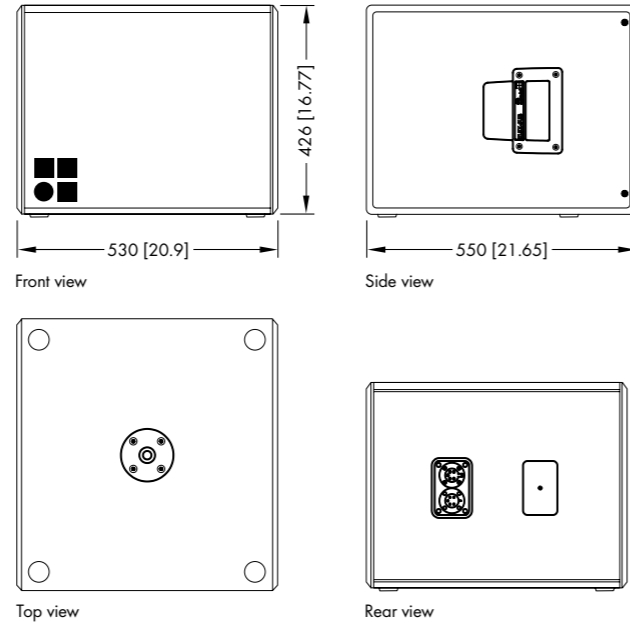

E15X-SUB cabinet dimensions in mm [inch]

The B4 subwoofer

B4 subwoofer

The B4-SUB is an actively driven cardioid subwoofer powered by a single amplifier channel. It houses two long excursion neodymium drivers in an integrated cardioid setup: a 15" driver in a bass-reflex design facing to the front and a 12" driver in a two chamber bandpass design radiating to the rear. The cardioid dispersion pattern resulting from this arrangement unwanted energy behind the system that greatly reduces the excitation of the reverberant field at low frequencies and provides the greatest accuracy of low frequency reproduction. The B4 subwoofer can only be used in a ground stacked configuration. The B4-SUB cabinet is constructed from marine plywood and has an impact and weather resistant paint finish and a pair of handles. An M20 threaded flange in the top panel accepts the d&b Loudspeaker stand winder M20. The front of the loudspeaker cabinet is protected by a rigid metal grill backed by an acoustically transparent foam. Two runners extend from the rear to the front panel of the cabinet protecting the bottom panel against scratching. Two correspondingly shaped recesses are incorporated in the top panel of each cabinet that accept these runners to prevent cabinet movement when stacked.

System data

Frequency response (-5 dB standard)40 - 150 Hz
 Frequency response (-5 dB 100 Hz mode).....40 - 100 Hz
 Max. sound pressure (1 m, free field)¹
 with D6/10D 128 dB
 with D20/30D 131 dB
 with D80 131 dB

Loudspeaker data

Nominal impedance6 ohms
 Power handling capacity (RMS/peak 10 msec)500/2000 W
 Components
 Front/Rear 15"/12" driver
 Connections2 x NLT4 F/M
 optional 2 x EP5 or 2 x NL4
 Weight..... 44 kg (97 lb)

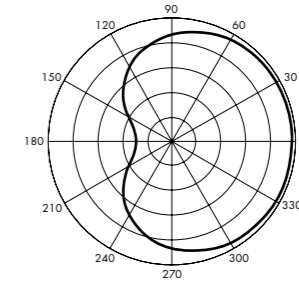

Cardioid polar pattern

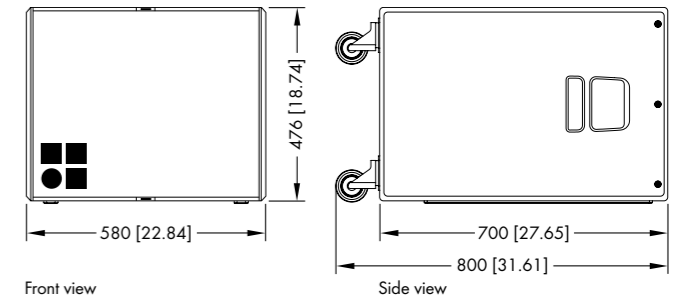

Front view

Side view

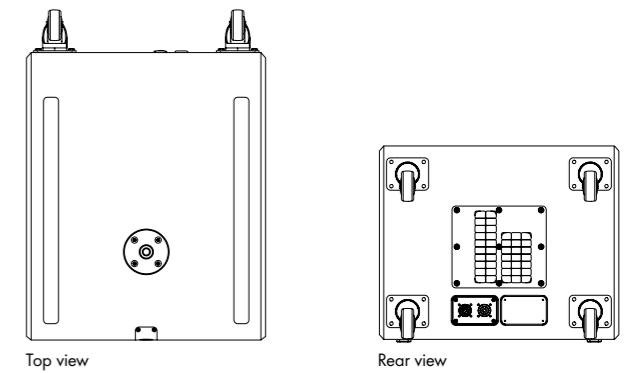

Top view

Rear view

B4-SUB cabinet dimensions in mm [inch]

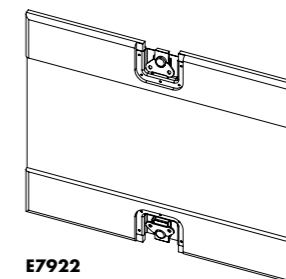

E7922 B4-SUB Wooden lid

The E4/E5 mounting accessories

Safety approval

d&b loudspeakers and accessories are designed for setup and use within situations requiring compliance with the provisions and directives of the DGUV regulation 17 (formerly BGV C1).



Z5356
Ball joint adapter

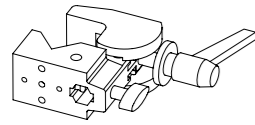

E6532
Super clamp
For tube diameters from
13 to 55 mm/0.5" to 2.17"



E6533
Adapter M10
for Super clamp

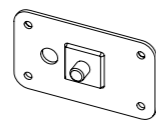

Z5038
Fixing plate M10



Z5029
TV spigot M10

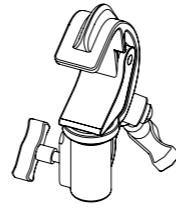

Z5012
Pipe clamp for TV spigot
For a tube diameter up to
70 mm/2.75"

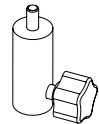

Z5034
Stand adapter M10



Z5035
Adapter M10 to 3/8"

The E4/E5 mounting examples

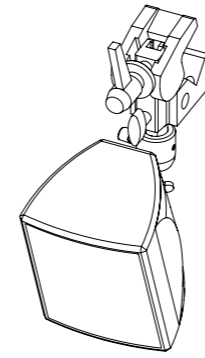

E4/E5 with
Z5356 Ball joint adapter
E6532 Super clamp
E6533 Adapter M10
for Super clamp

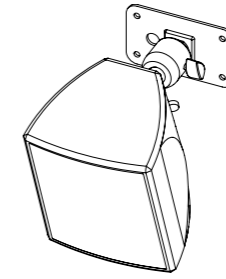

E4/E5 with
Z5356 Ball joint adapter
Z5038 Fixing plate M10

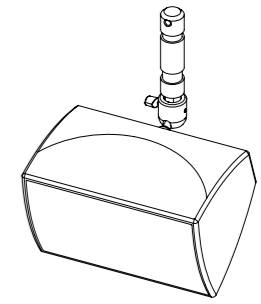

E4/E5 with
Z5356 Ball joint adapter
Z5029 TV spigot M10

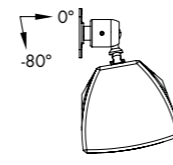

E4 angle settings

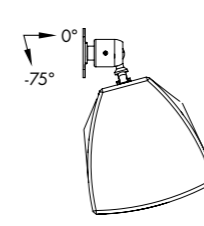
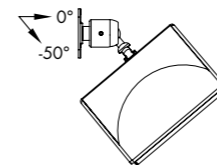

E5 angle settings

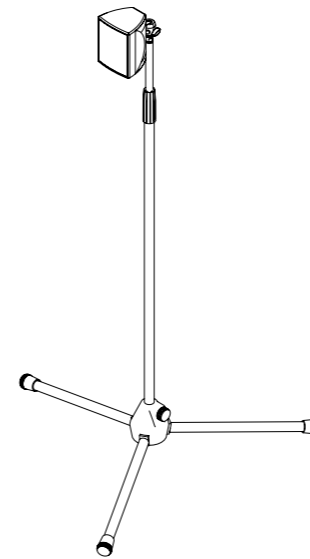
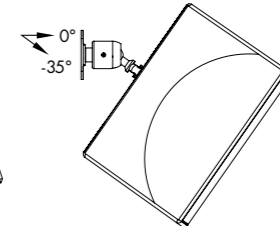

E4/E5 mounted on a microphone stand with
Z5356 Ball joint adapter
Z5035 Adapter M10 to 3/8"

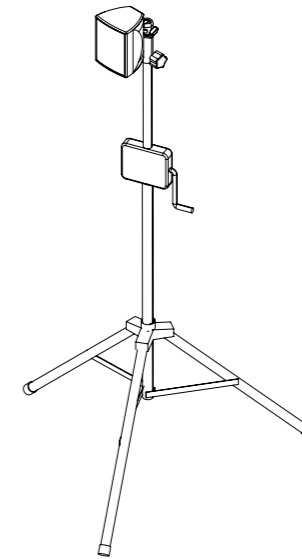

E4/E5 with
Z5356 Ball joint adapter
Z5034 Stand adapter M10
Z5009 Loudspeaker stand with winder

The E6 mounting accessories

Safety approval

d&b loudspeakers and accessories are designed for setup and use within situations requiring compliance with the provisions and directives of the DGUV regulation 17 (formerly BGV C1).

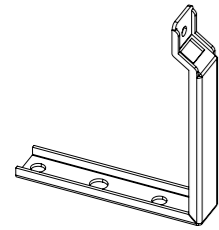

Z5377
E6 Swivel bracket

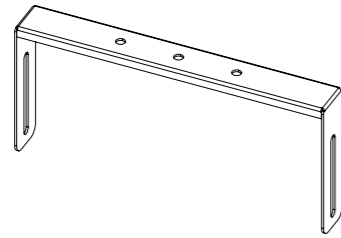

Z5378
E6 Horizontal bracket

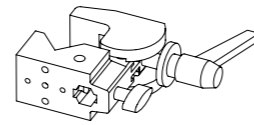

E6532
Super clamp
For tube diameters from
13 to 55 mm/0.5" to 2.17"



E6533
Adapter M10
for Super clamp

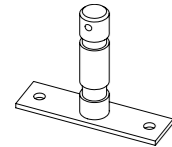

Z5010
TV spigot
with fixing plate

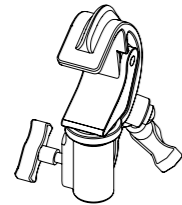

Z5012
Pipe clamp for TV spigot
For a tube diameter up to
70 mm/2.75"

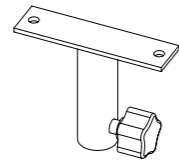

Z5024
Loudspeaker
stand adapter

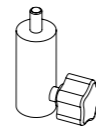

Z5034
Stand adapter M10



Q9031
Safety eyebolt M8

The E6 mounting examples

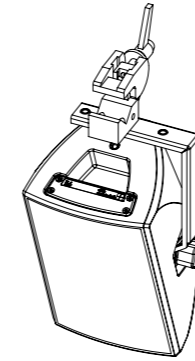

E6 with
Z5377 E6 Swivel bracket
E6532 Super clamp
E6533 Adapter M10
for Super clamp

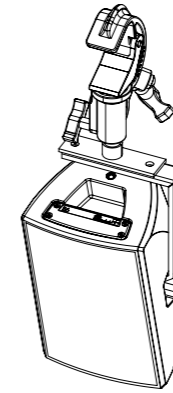

E6 with
Z5377 E6 Swivel bracket
Z5010 TV spigot with fixing plate
Z5012 Pipe clamp

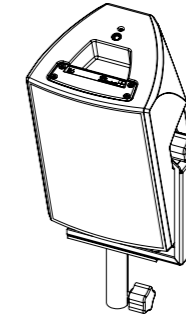

E6 with
Z5377 E6 Swivel bracket
Z5024 Loudspeaker stand adapter

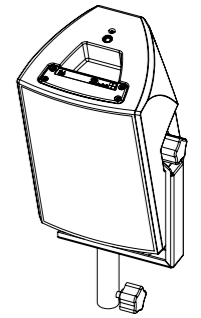

E6 with
Z5377 E6 Swivel bracket
Z5034 Stand adapter M10

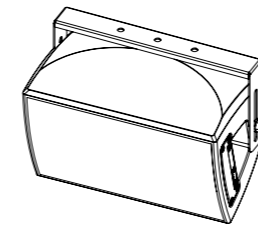

E6 with
Z5378 E6 Horizontal bracket

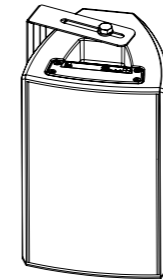

E6 with
Z5378 E6 Horizontal bracket

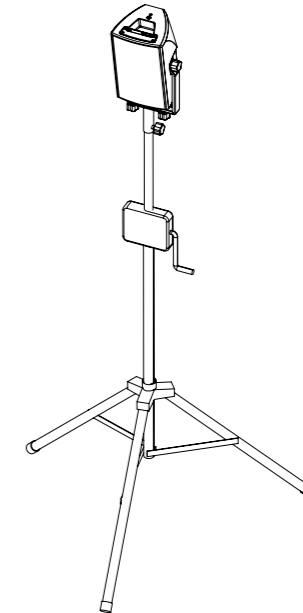

E6 with
Z5377 E6 Swivel bracket
Z5024 Loudspeaker stand
adapter
Z5009 Loudspeaker stand
with winder

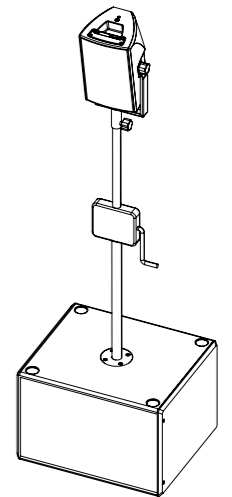

E6 with
Z5377 E6 Swivel bracket
Z5034 Stand adapter M10
Z5013 Loudspeaker stand
winder M20

The E8/E12 mounting accessories

Safety approval

d&b loudspeakers and accessories are designed for setup and use within situations requiring compliance with the provisions and directives of the DGUV regulation 17 (formerly BGV C1).

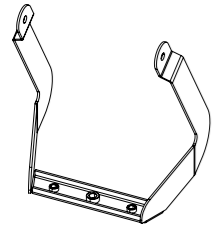

Z5350
E8 Flying bracket
Z5352
E12 Flying bracket

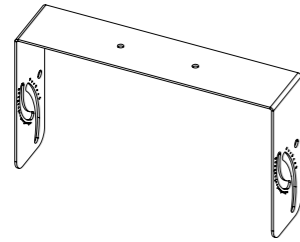

Z5351
E8 Horizontal bracket
Z5353
E12 Horizontal bracket

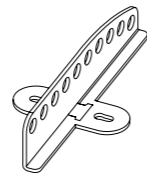

Z5354
E8/E12 Flying adapter



Z5355
E8/E12 Flying adapter link

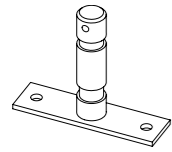

Z5010
TV spigot
with fixing plate

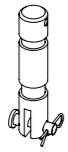

Z5015
TV spigot 02



Z5012
Pipe clamp for TV spigot
For a tube diameter up to
70 mm/2.75"

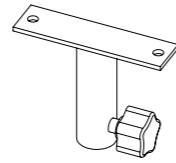

Z5024
Loudspeaker
stand adapter

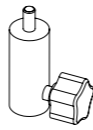

Z5034
Stand adapter M10



Q9032
Safety eyebolt M10

The E8/E12 mounting examples

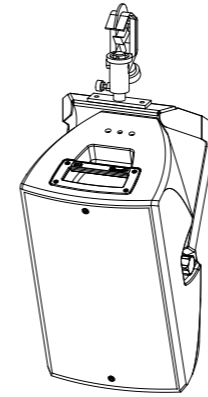

E8/E12 with
Z5350 E8 Flying bracket or
Z5352 E12 Flying bracket
Z5010 TV spigot with fixing plate
Z5012 Pipe clamp

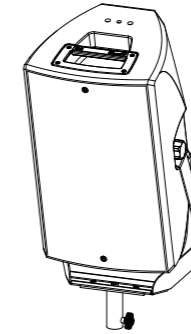

E8/E12 with
Z5350 E8 Flying bracket or
Z5352 E12 Flying bracket
Z5024 Loudspeaker stand adapter

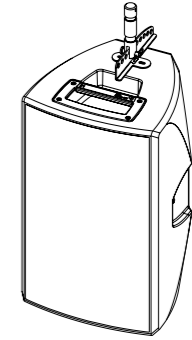

E8/E12 with
Z5354 E8/E12 Flying adapter
Z5015 TV spigot 02

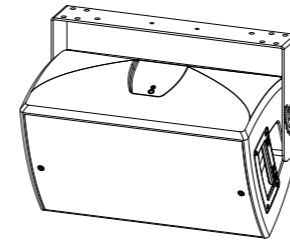

E8/E12 with
Z5351 E8 Horizontal bracket or
Z5353 E12 Horizontal bracket

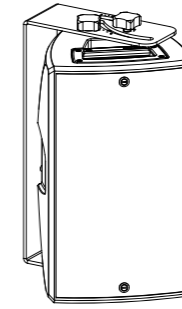

E8/E12 with
Z5351 E8 Horizontal bracket or
Z5353 E12 Horizontal bracket

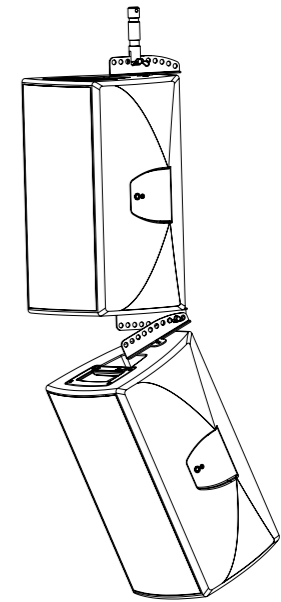

E8 or E12 vertically arrayed for
far and near field coverage with
Z5354 E8/E12 Flying adapter
Z5355 E8/E12 Flying adapter link
Z5015 TV spigot 02

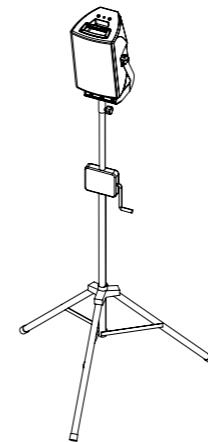

E8/E12 with
Z5350 E8 or Z5352 E12 Flying bracket
Z5034 Stand adapter M10
Z5009 Loudspeaker stand with winder

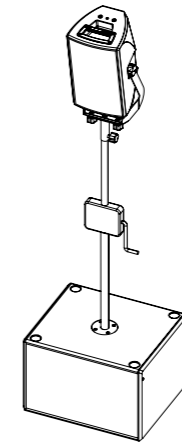

E8/E12 with
Z5350 E8 or Z5352 E12 Flying bracket
Z5024 Loudspeaker stand adapter
Z5013 Loudspeaker stand winder M20

The E-Series Weather Resistant and Special Colour options

The E-Series cabinets are also available with a Weather Resistant or Special Colour option. The B4-SUB cabinet is only available in the Special Colour option. When either of these is requested, the loudspeakers are subsequently supplied with metal plates to cover the handles and threaded flange. Both options can be combined.

Weather Resistant (WR) option

The WR option enables operation in changing ambient conditions, however it is not intended to enable permanent, unprotected operation of loudspeakers outdoors. An additional cover should be positioned over any of these loudspeakers, when used outdoors. The E-Series cabinets with the WR option are supplied with a fixed input cable (type H-07-RN-F 2 x 2.5 mm²/AWG 13). The E4 and E5 are weather protected and suitable for outdoor use as standard.

Special Colour (SC) option

The SC option is available in all colours of the RAL colour table. The acoustically transparent foam or fabric fitted behind the rigid metal grill is also painted with the requested RAL colour. The SC version is supplied with NL4 connectors.

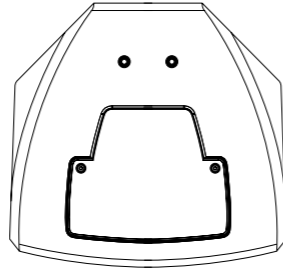

E6 WR/SC option top view and E8, E12 and WR/SC options top and bottom view

The E4 and E5 cases

The E7460 Touring case is also supplied with four extra 'E4 foam insert sets' each comprising two bottom inserts and one upright divider. These insert sets enable each of the E5 compartments to be transformed to accommodate two E4 loudspeakers. A set can either be permanently fixed in place or used as and when required. The photographs below show two examples of how the case can be converted.



E7458
Touring case 4 x E4



E7458 Touring case for
4 x E4 loudspeaker
4 x Z5356 Ball joint adapter
4 x E6532 Super clamp



E7460
Touring case 4 x E5



E7460 Touring case for
4 x E5 loudspeaker
4 x Z5356 Ball joint adapter
4 x E6532 Super clamp



E7460 Touring case with
4 x E5 loudspeaker
4 x Z5356 Ball joint adapter
4 x E6532 Super clamp



E7460 Touring case with
4 x E4 loudspeaker
2 x E5 loudspeaker
6 x Z5356 Ball joint adapter
4 x E6532 Super clamp



E7460 Touring case with
8 x E4 loudspeaker
8 x Z5356 Ball joint adapter
4 x E6532 Super clamp

The d&b ArrayCalc simulation software

The d&b NoizCalc immission modelling software

The d&b ArrayCalc simulation software is the simulation tool for d&b line arrays, column and point source loudspeakers as well as subwoofers. This is a comprehensive toolbox for all tasks associated with acoustic design, performance prediction, alignment, rigging and safety parameters. d&b ArrayCalc is available as a native stand-alone application for both Microsoft Windows¹ and Mac OS X² operating systems. In combination with the d&b Remote network, this can significantly reduce setup and tuning time in mobile applications, and allows for precise initial simulations when planning installations. Listening planes can be defined in the venue tab, creating a three dimensional representation of any audience area in a given venue. All sources can be time aligned, and the phase response of a flown system and a ground stacked SUB array can be aligned at a definable reference point. The comprehensive simulation precisely models the actual performance of the system, taking into account input level, all system configuration options (such as CUT, CPL, HFC or INFRA), limiter headroom and air absorption. Acoustic obstacles, such as video screens, can be added to a model. Acoustic shadowing, whether by these obstacles, or a balcony overhang, is taken into consideration. The level distribution resulting from the interaction of all active sources can be mapped onto the audience areas in a three-dimensional view. The Remote ID for all devices can be managed in the amplifier tab. EASE and DXF data export capabilities are also available.

A reference point can be defined for the d&b NoizCalc software, which can be used to model the far field noise immission from a d&b sound reinforcement system. NoizCalc uses loudspeaker data from the ArrayCalc simulation file and displays the immission on a terrain map, presenting the calculated Sound Pressure Levels in dB(A) applying the selected frequency spectrum using either the ISO 9613-2 or Nord2000 standards. The R1 Remote control software uses the data defined in ArrayCalc to generate an intuitive graphical user interface including the complete setup of the simulated system and all configuration information. This workflow removes the need to manually transfer data from one software program to the other. Further information is provided in the d&b Amplifier and Software brochure which is available for download at www.dbaudio.com.

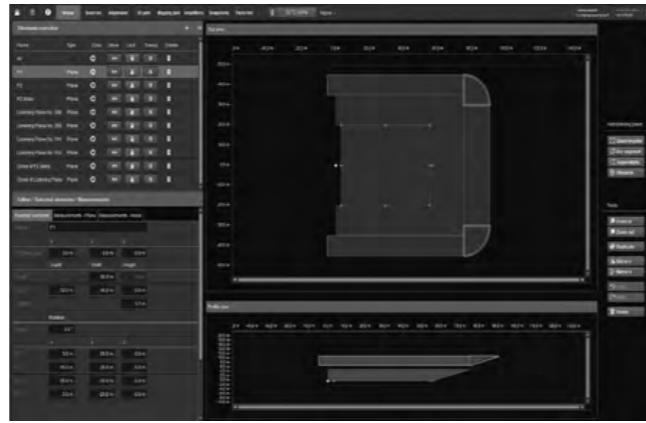

Venue

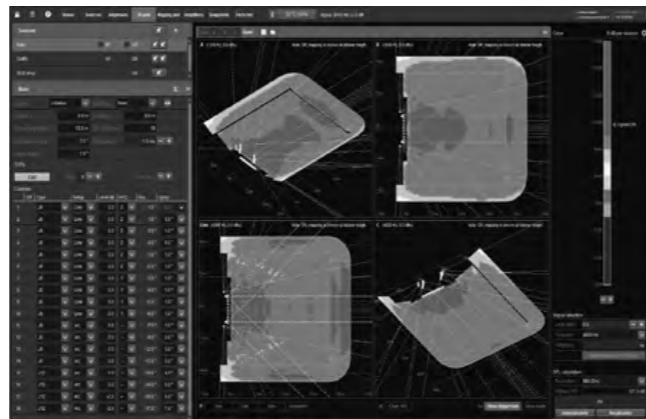

3D Plot quad

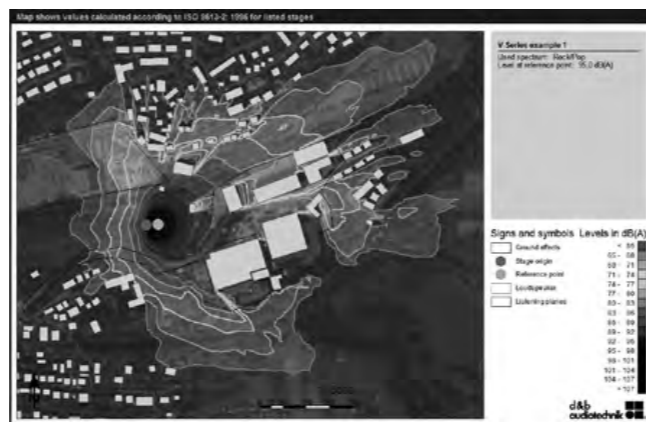

NoizCalc results map

¹ Microsoft Windows is a registered trademark or trademark of Microsoft Corporation in the United States and/or other countries
² Mac OS X is a trademark of Apple Inc., registered in the U.S. and other countries

The d&b R1 Remote control software

The remote control capability of the d&b Remote network enables central control and monitoring of a complete d&b loudspeaker system from anywhere in the network, be it from a computer in the control room, at the mix position, or on a wireless tablet in the auditorium. This central access to all functions through the d&b Remote network, to controls as well as detailed system and device diagnostics information, unlocks the full potential of the d&b system approach. In a typical user workflow, the d&b Remote network takes settings optimized in the ArrayCalc simulation software and applies these to all the amplifiers within the network. The importation of settings from ArrayCalc allows the system configuration to be quickly accomplished, providing more time for verification and fine tuning.

All features, functions and controls available on the front panel of d&b amplifiers may be remotely controlled and/or monitored using R1 Remote control software. This allows each channel of the amplifier to be controlled and enables the creation of groups of loudspeakers. When grouped together, a button or fader can control the overall system level, zone level, equalization and delay, power ON/OFF, MUTE, as well as loudspeaker specific function switches such as CUT/HFA/HFC and CPL. An offline mode is provided for preparation in advance of an event, without the amplifiers being present or connected.

For mobile applications, d&b System check verifies that the system performs within a predefined condition. Extensive facilities for storing and recalling system settings are provided allowing these to be repeated, as and when required. Project files can be easily adjusted for use with a different set of equipment at another location.

In installation projects system integrators can configure the d&b Remote network to offer access to different levels of control, tailored to the operational demands. For example, power ON/OFF for daily use, or more complex functionality for detailed control. Password protection is available to restrict access. Input and Load monitoring allow installation operators to ensure optimum performance at all times.

R1 Remote control software enables d&b amplifiers to be remotely controlled using both Ethernet and CAN-Bus in parallel. The software is optimized for use with touch screen, mouse and keyboard and runs on both Microsoft Windows¹ (Win7 or higher) and Mac OS X² (10.7 or higher) operating systems. Further information is provided in the d&b Amplifier and Software brochure which is available for download at www.dbaudio.com.

¹ Microsoft Windows is a registered trademark or trademark of Microsoft Corporation in the United States and/or other countries
² Mac OS X is a trademark of Apple Inc., registered in the U.S. and other countries



Home



Remote in Configuration mode

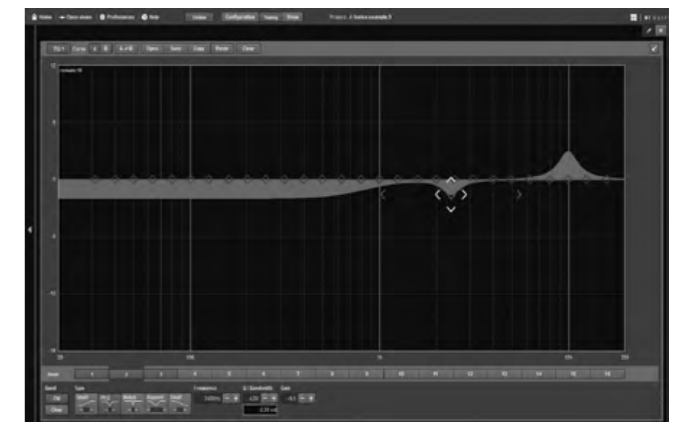

16-band equalizer

The d&b amplifiers

The d&b amplifiers are designed specifically to power d&b loudspeakers and are the beating heart of the d&b System reality. As such, they incorporate Digital Signal Processing for comprehensive loudspeaker management, switchable filter functions, remote capabilities and user-definable controls, to fulfil the exact needs of each application. Every loudspeaker configuration combines comprehensive system limiting, and equalization and crossover settings to ensure consistent results and optimal performance. d&b amplifiers offer

different output configurations for different loudspeaker setups, including Dual Channel mode, for passive setups, Mix TOP/SUB mode, in which two channels are driven through a single output connector, and 2-Way Active mode, which also sends the output of two channels down one connector to drive appropriate loudspeakers actively. The d&b switch functions provide selected filters to precisely tailor a wide variety of setups to their applications. Examples of these switch functions are the CSA (Cardioid Subwoofer Array)

and HFC (High Frequency Compensation) modes. CSA increases low frequency directivity control by minimising energy transmission towards the rear while HFC compensates for air absorption for loudspeakers covering far field listening positions. In addition to these functions, d&b amplifiers offer a comprehensive set of specific filters such as CUT, a cut mode for TOP loudspeakers when used with d&b subwoofers; CPL, to compensate for the coupling effect between loudspeakers in close proximity to other loudspeakers or hard objects and HFA

mode, to attenuate the high frequencies of a loudspeaker to mimic the effect of far field listening. These devices offer extended, user-definable equalization and delay capabilities, eliminating the need for external processing devices in the signal chain. All d&b amplifiers integrate with the d&b Remote network to enable the remote control and management of systems from anywhere within a network. Further information is provided in the d&b Amplifier and Software brochure which is available for download at www.dbaudio.com.

Comparison of the d&b amplifiers

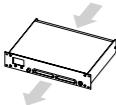
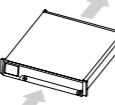
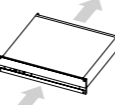
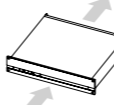
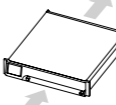
	D6	D20	10D	30D	D80
User interface	Encoder/LC display	Encoder/colour TFT touchscreen	LED indicators	LED indicators	Encoder/colour TFT touchscreen
Output channels	2	4	4	4	4
Input channels	2 x AES3 or 2 x analog	4 x AES3 or 4 x analog or 2 x AES3 and 2 x analog	4 x AES3 and 4 x analog	4 x AES3 and 4 x analog	4 x AES3 or 4 x analog or 2 x AES3 and 2 x analog
Latency	0.3 msec	0.3 msec	0.3 msec	0.3 msec	0.3 msec
User equalizers (per channel)	4-band	2 x 16-band	2 x 16-band	2 x 16-band	2 x 16-band
Delay	340 msec/116.9 m	10 sec/3440 m	10 sec/3440 m	10 sec/3440 m	10 sec/3440 m
Maximum output power (THD+N < 0.5%, 12 dB crest factor)	2 x 350 W into 8 ohms 2 x 600 W into 4 ohms	4 x 800 W into 8 ohms 4 x 1600 W into 4 ohms	4 x 350 W into 8 ohms 4 x 700 W into 4 ohms	4 x 800 W into 8 ohms 4 x 1600 W into 4 ohms	4 x 2000 W into 8 ohms 4 x 4000 W into 4 ohms
Output routing	Dual Channel	Dual Channel, Mix TOP/SUB 2-Way Active	Dual Channel, Mix TOP/SUB 2-Way Active	Dual Channel, Mix TOP/SUB 2-Way Active	Dual Channel, Mix TOP/SUB 2-Way Active
Output connectors	NL4	NL4 plus central NL8	Phoenix Euroblock	Phoenix Euroblock	NL4/EP5 plus central NL8
GPIO connector, 5 ports	No	No	Phoenix Euroblock	Phoenix Euroblock	No
Cable compensation	No	LoadMatch	LoadMatch	LoadMatch	LoadMatch
Power supply	Autosensing switched mode power supply with active PFC	Universal range switched mode power supply with active PFC	Universal range switched mode power supply with active PFC	Universal range switched mode power supply with active PFC	Autosensing switched mode power supply with active PFC
Mains voltage	100 - 120/220 - 240, 50 - 60 Hz	100 - 240 V, 50 - 60 Hz	100 - 240 V, 50 - 60 Hz	100 - 240 V, 50 - 60 Hz	100 - 127/208 - 240 V, 50 - 60 Hz
Weight (kg/lb)	8/17.6	10.8/23.8	10.6/23.4	10.6/23.4	19/42
Dimensions	2 RU x 19" x 353 mm	2 RU x 19" x 460 mm	2 RU x 19" x 435 mm	2 RU x 19" x 435 mm	2 RU x 19" x 530 mm
Remote	CAN	OCA via Ethernet/CAN	OCA via Ethernet/CAN	OCA via Ethernet/CAN	OCA via Ethernet/CAN
Airflow					

The operation with d&b amplifiers

Amplifier controller setups

CUT mode

Set to CUT, the cabinet low frequency level is reduced and is configured for use with d&b active subwoofers.

HFA mode

In HFA mode (High Frequency Attenuation), the HF response is rolled off. The HFA provides a natural, balanced frequency response when a unit is placed close to listeners in near field or delay use. HFA begins gradually at 1 kHz, dropping by approximately 3 dB at 10 kHz. This roll off mimics the decline in frequency response experienced when listening to a system from a distance in a typically reverberant room or auditorium.

CPL function

The CPL (Coupling) function compensates for coupling effects between closely coupled cabinets by reducing the low and mid frequency level. CPL begins gradually at 1 kHz, with maximum attenuation below 250 Hz (200 Hz for E4 and E5), providing a balanced frequency response when cabinets are used in arrays of two or more. The CPL function can be set in dB attenuation values between -9 and 0, or a positive CPL value which creates an adjustable low frequency boost (0 to +5 dB).

100 Hz mode

The 100Hz mode limits the upper operating frequency of the subwoofer to 100Hz, complementing top cabinets in full range mode.

140 Hz mode

For acoustic adjustment the 140 Hz mode can be selected. When the 140 Hz mode is selected, the upper operating frequency of the system is raised to 140 Hz. This may be selected to supplement E-Series loudspeakers operating in CUT mode, when the coupling of the systems requires more energy in this frequency band.

Passive operation of E12X-SUB in parallel to E8

The E8-X configuration in the d&b amplifiers should be selected when an E8 loudspeaker is used in combination with E12X subwoofers in passive mode driven from one amplifier channel. Compared to the standard E8 configuration, the E8-X configuration provides a dedicated correction for the combined frequency response of the loudspeaker and subwoofer. Selecting

the E8-X configuration enables a combination of up to three E8 and E12X-SUBs to be driven by the respective channel.

Passive operation of E15X-SUB in parallel to E12/E12-D

The E12-X or E12-DX configurations in the d&b amplifiers should be selected when E12 or E12-D loudspeakers are used in combination with E15X-SUB loudspeakers in passive mode driven from one amplifier channel. Compared to the standard E12 and E12-D configurations, the E12-X and E12-DX configurations provide a dedicated correction for the combined frequency response of the loudspeaker and subwoofer. Selecting the E12-X or E12-DX configurations enables a combination of one E12/E12-D and one E15X-SUB loudspeakers to be driven by the respective channel.

Recommended amplifiers for mobile applications

	E4	E5	E6	E8	E12/E12-D	E12X-SUB	E15X-SUB	B4-SUB
D6	x	x						
D20	x	x	x	x	x	x	x	x

Recommended amplifiers for installation applications

	E4	E5	E6	E8	E12/E12-D	E12X-SUB	E15X-SUB	B4-SUB
D6	x	x						
10D	x	x						
30D			x	x	x	x	x	x

Maximum loudspeakers per amplifier channel

	E4	E5	E6	E8	E12/E12-D	E12X-SUB	E15X-SUB	B4-SUB
	4	4	4	4	2	2	2	2

Available controller settings

	E4	E5	E6	E8	E12/E12-D	E12X-SUB	E15X-SUB	B4-SUB
CUT	x	x	x	x	x			
HFA	x	x	x	x	x			
CPL	x	x	x	x	x			
100 Hz							x	x
140 Hz						x		

The E-Series frequency responses

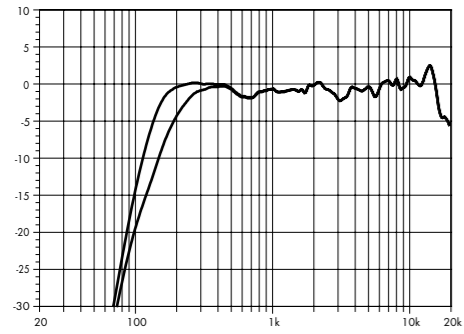

E4 standard and CUT

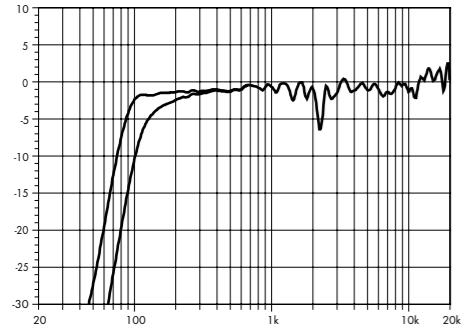

E6 standard and CUT

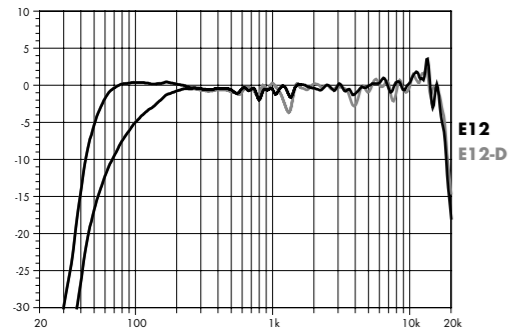

E12/E12-D standard and CUT

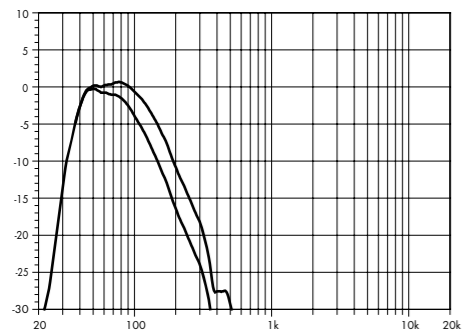

E15X-SUB standard and 100 Hz

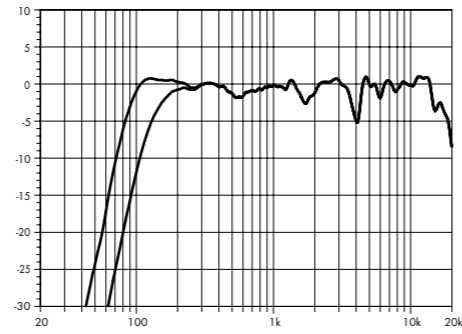

E5 standard and CUT

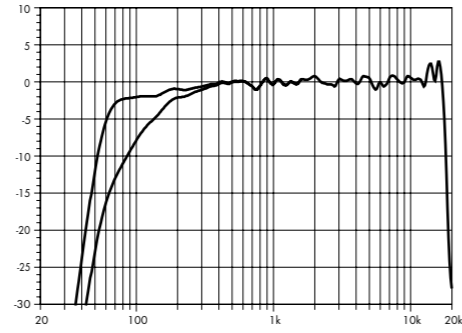

E8 standard and CUT

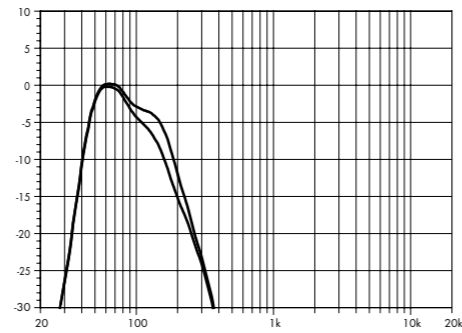

E12X-SUB standard and 140 Hz

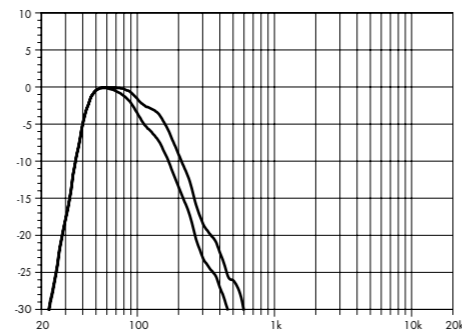

B4-SUB standard and 100 Hz

The d&b amplifier output modes

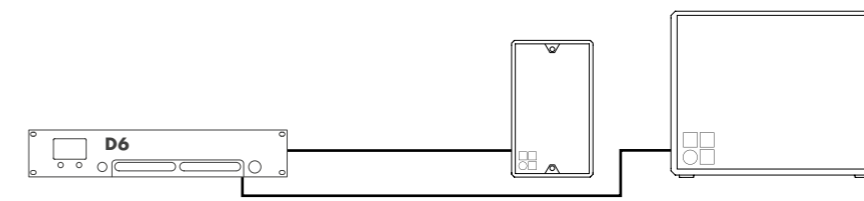

D6 amplifier in Dual Channel mode for E4, E5, E6, E8, E12 or E12-D and E12X-SUB, E15X-SUB or B4-SUB

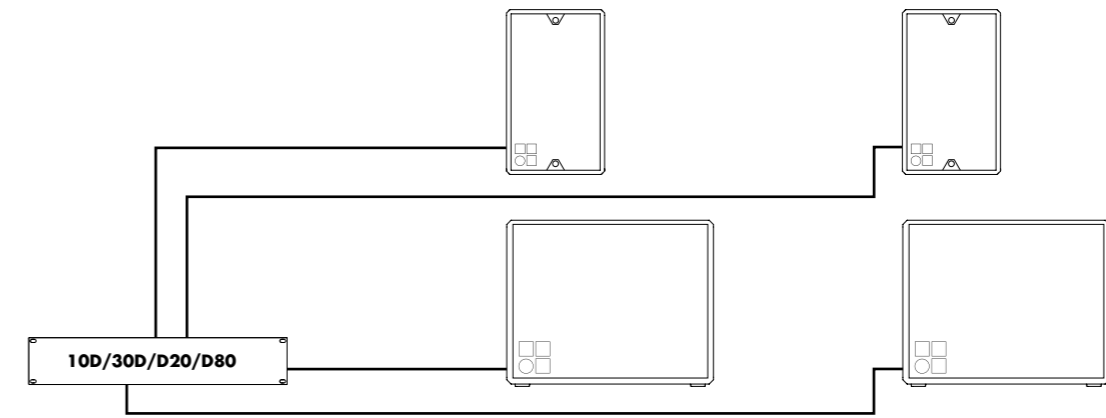

10D/30D/D20/D80 amplifier in Dual Channel mode for E4, E5, E6, E8, E12 or E12-D and E12X-SUB, E15X-SUB or B4-SUB

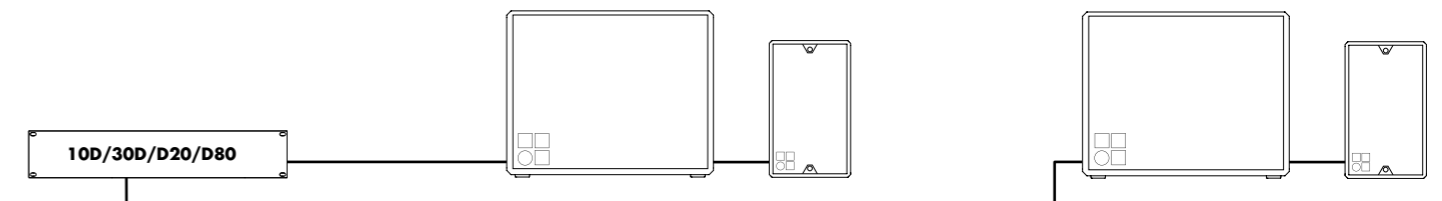

10D/30D/D20/D80 amplifier in Mix TOP/SUB mode for E4, E5, E6, E8, E12, E12-D, E12X-SUB, E15X-SUB and B4-SUB

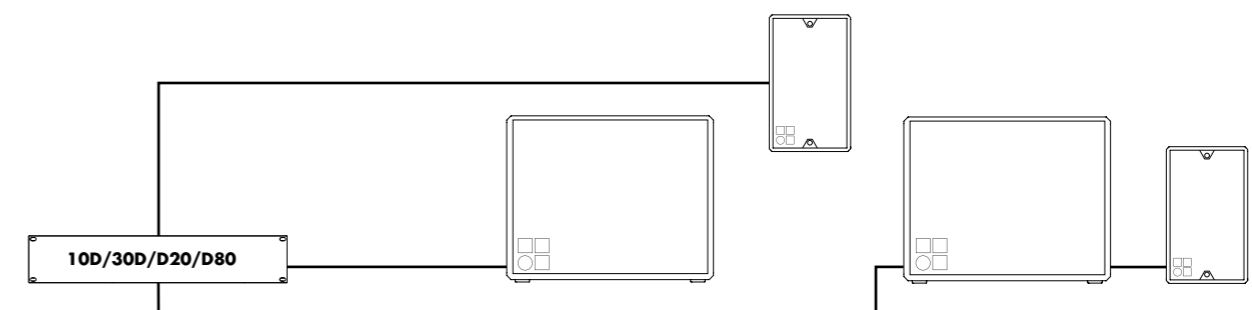

10D/30D/D20/D80 in a mixed configuration of Dual Channel and Mix TOP/SUB modes for E4, E5, E6, E8, E12, E12-D, E12X-SUB, E15X-SUB and B4-SUB

The DS10 Audio network bridge

The DS10 Audio network bridge interfaces between Dante networks and AES3 digital audio signals, while also providing distribution of Ethernet control data. Positioned within the signal chain in front of the amplifiers, this 1 RU device expands the d&b system approach in both mobile and installation environments. Each unit can deliver up to sixteen Dante network channels via AES3 digital signal outputs. The AES3 channel streams from the DS10 carry meta data with Dante channel labels and cabling information to the four channel d&b amplifiers. Additionally, four AES3 input channels provide access to the Dante audio network for applications such as a break-in from a Front of House console. The DS10 incorporates an integrated 5-port switch, offering a primary and redundant network for the Dante protocol, as well as advanced functions such as Multicast Filtering and VLAN modes. This extensive switch flexibility provides extended connectivity for a laptop to control the d&b amplifiers using the R1 Remote control software via the OCA (Open Control Architecture) protocol. Using the DS10 Audio network bridge, audio signals and remote control data can be combined using a single Ethernet cable. The DS10 features a power supply suitable for mains voltages 100 V - 240 V, 50 - 60 Hz, with Overvoltage protection of up to 400 V.

Control and indicators

BYPASS/NETWORK..... Toggle switch
 Switch port modes/Audio loss..... LED indicators
 SYNC ERROR Red LED indicator
 SUBSCRIBED (RX Subscription) Green LED indicator

Connectors

DIGITAL IN..... 3 pin XLR female AES3
 Input sampling 32 - 192 kHz
 Input synchronization..... Sample Rate Converter (SRC)
 DIGITAL OUT 3 pin XLR male AES3
 Output sampling 48/96 kHz
 Output synchronization Dante network
 Network etherCON¹
 built-in 5-port Ethernet switch
 100/1000 Mbit

Power supply

Mains connector..... powerCON¹
 Rated mains voltage 100 - 240 V, 50 - 60 Hz

Dimensions, weight

Height x width x depth..... 1 RU x 19" x 232 mm
 Weight..... 3.75 kg (8.26 lb)

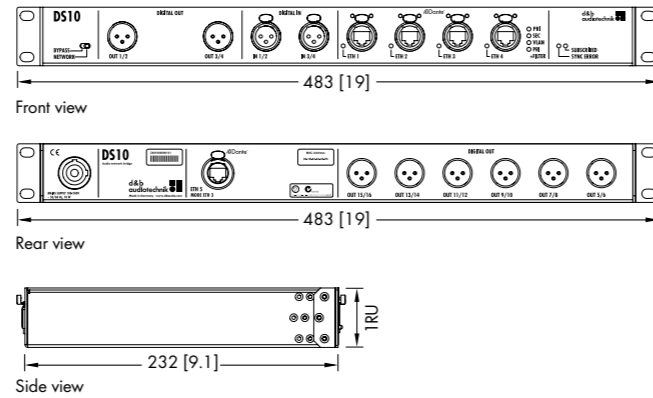

DS10 Audio network bridge dimensions mm [inch]

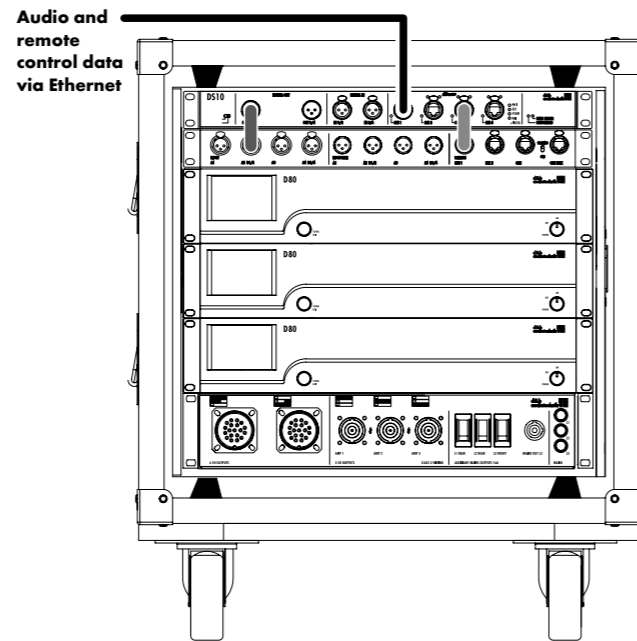

DS10 sending audio and remote control data to D80 amplifiers

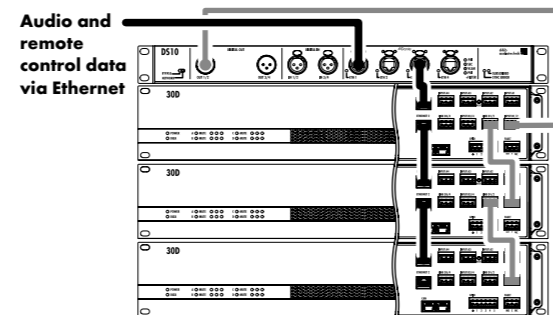

DS10 sending audio and remote control data to 30D amplifiers

The E-Series configuration examples

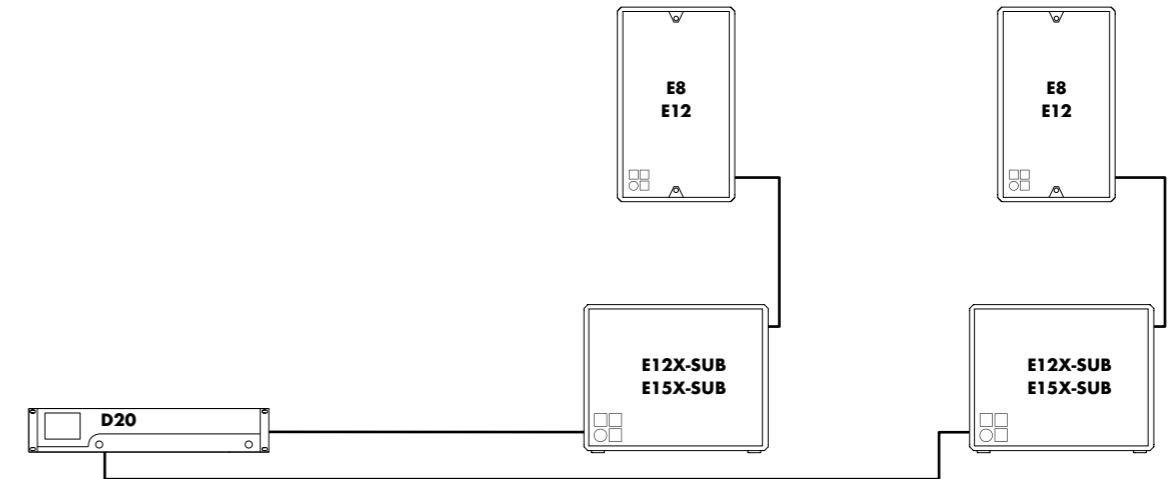

D20 amplifier in Mix TOP/SUB mode with E8 or E12 loudspeakers and E12X or E15X subwoofers



D20 amplifier in Mix TOP/SUB mode with E12 loudspeakers and B4 subwoofers as a powerful PA system and D6 amplifier in Dual Channel mode with E5 loudspeakers as nearfills

The E-Series cables and adapters

Amplifiers in Dual Channel mode

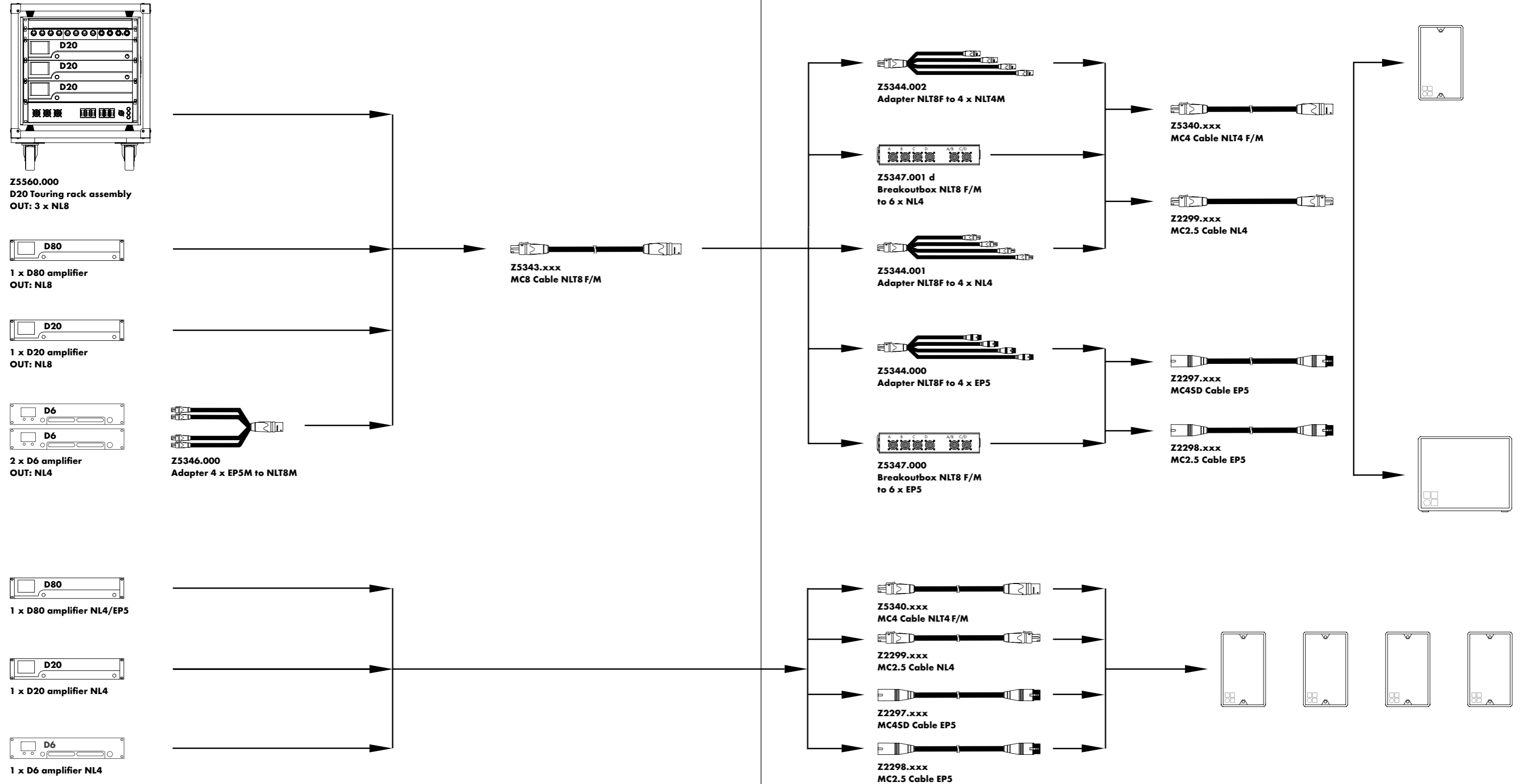

The E-Series product overview

Loudspeakers	Z0440.000 Z0450.000 Z0350.xxx Z0620.xxx Z0601.xxx Z0602.xxx Z0210.xxx Z0615.xxx Z0610.xxx	E4 Loudspeaker NL4 connector E5 Loudspeaker NL4 connector E6 Loudspeaker E8 Loudspeaker E12 Loudspeaker E12-D Loudspeaker E12X Subwoofer E15X Subwoofer B4 Subwoofer WR Weather Resistant ¹ SC Special Colour ²
Loudspeaker connector options	Zxxxx.000 Zxxxx.001 Zxxxx.002	EP5 connector NL4 connector NLT4 F/M connector
Loudspeaker cases	E7458.000 E7460.000 E7456.000 E7457.000 E7446.000 E7447.000 E7445.000 E7448.000 E7449.000	Touring case 4 x E4 integral tray, handle Touring case 4 x E5 integral tray, handle Touring case 2 x E6 hinged lid, integral tray, handles Touring case 4 x E6 hinged lid, integral tray, wheels Touring case 2 x E8 hinged lid, integral tray, handles Touring case 4 x E8 hinged lid, integral tray, wheels Touring case 2 x E12 hinged lid, integral tray, wheels Touring case 2 x E15X-SUB sleeve, wheels Touring case 2 x E12X-SUB sleeve, wheels
Lid	E7922.000	B4-SUB Wooden lid
Accessories	Z5356.000 E6532.000 E6533.000 Z5038.000 Z5029.000 Z5034.000 Z5035.000 Z5377.000 Z5378.000 Z5350.000 Z5351.000 Z5352.000 Z5353.000 Z5354.000 Z5355.000 Z5010.000 Z5015.000 Z5012.500 Z5009.000 Z5013.000	Ball joint adapter ² Super clamp Adapter M10 for Super clamp Fixing plate M10 TV spigot M10 Stand adapter M10 Adapter M10 to 3/8" E6 Swivel bracket ² E6 Horizontal bracket ² E8 Flying bracket ² E8 Horizontal bracket ² E12 Flying bracket ² E12 Horizontal bracket ² E8/E12 Flying adapter ² E8/E12 Flying adapter link TV Spigot with fixing plate TV Spigot for Flying adapter 02 Pipe clamp for TV spigot Loudspeaker stand with winder Loudspeaker stand winder M20

¹ WR on request
² SC on request
³ Available as a download at www.dbaudio.com

	Z5024.000 Q9031.000 Q9032.000	Loudspeaker stand adapter Safety eyebolt M8 Safety eyebolt M10
Remote network	Z3010.000 Z6118.000 Z6124.000 Z6116.000 Z6122.000 Z6123.000	R1 Remote control software ³ R60 USB to CAN interface R70 Ethernet to CAN interface RJ 45 M Terminator Bopla mounting clamp Bopla mounting clamp upright
Amplifiers	Z2700.xxx Z2750.xxx Z2760.xxx Z2770.xxx Z2710.xxx	D6 Amplifier ⁴ D20 Amplifier ⁴ 10D Amplifier ⁵ 30D Amplifier ⁵ D80 Amplifier ⁴
Audio networking	Z4010.000 Z5563.000 Z5339.000	DS10 Audio network bridge DS10 Rack upgrade kit Multichannel extension cable
Amplifier rack assemblies	Z5560.000 Z5561.000 Z5330.001 Z5562.001 Z5330.xxx	D20 Touring rack assembly CEE 32A 5P, NL4 ⁶ D20 Touring rack assembly CEE 32A 5P, NL4, DS10 ⁶ D80 Touring rack assembly, CEE 32A 5P, NL4 ⁶ D80 Touring rack assembly, CEE 32 A 5P, NL4, DS10 ⁶ D80 Touring rack assembly, Nema L21-30 (120V devices) on request ⁶
Amplifier racks	E7480.000 E7468.000	D20 Touring rack 2 RU 19" SD, shock mounted, handles D80 Touring rack 2 RU, 19" SD, shock mounted, handles
Cables	Z5343.xxx Z5346.000 Z5345.001 Z5344.002 Z5344.001 Z5344.000 Z5347.001 Z5347.000 Z5340.xxx Z2299.xxx Z2297.xxx Z2298.xxx	MC8 Cable NLT8 F/M Adapter 4 x EP5M to NLT8M Adapter 4 x NL4 to NLT8M Adapter NLT8F to 4 x NLT4M Adapter NLT8F to 4 x NL4 Adapter NLT8F to 4 x EP5 Breakoutbox NLT8 F/M to 6 x NL4 Breakoutbox NLT8 F/M to 6 x EP5 MC4 Cable NLT4 F/M MC2.5 Cable NL4 MC4SD Cable EP5 MC2.5SD Cable EP5
Misc.	Z5061.000	Standard cabinet paint 1 kg/2.2 lb

⁴ The complete list of mobile amplifier versions is available in the D Amplifier and Software brochure
⁵ The complete list of installation amplifier versions is available in the xD Installation Amplifier and Software brochure
⁶ Further information is available in the d&b D Amplifier and Software brochure

