

T10

Manual 1.1 en



Symbols on the equipment

Please refer to the information in the operating manual.

WARNING!
Dangerous voltage!

Contents

Safety precautions.....	3
Information regarding use of loudspeakers.....	3
T10.....	4
T-Series rigging components and arrays.....	4
Connections.....	5
Operation.....	5
Dispersion characteristics.....	7
Altering the HF dispersion.....	7
Technical specifications.....	8
Manufacturer's Declarations.....	9
EU conformity of loudspeakers (CE symbol).....	9
WEEE Declaration (Disposal).....	9

General Information

T10 Manual

Version 1.1 en, 03/2016, D2600.EN .01

Copyright © 2016 by d&b audiotechnik GmbH; all rights reserved.

Keep this manual with the product or in a safe place so that it is available for future reference.

When reselling this product, hand over this manual to the new customer.

If you supply d&b products, please draw the attention of your customers to this manual. Enclose the relevant manuals with the systems. If you require additional manuals for this purpose, you can order them from d&b.

d&b audiotechnik GmbH
Eugen-Adolff-Strasse 134, D-71522 Backnang, Germany
Telephone +49-7191-9669-0, Fax +49-7191-95 00 00
E-mail: docadmin@dbaudio.com, Internet: www.dbaudio.com

Safety precautions



WARNING!

Information regarding use of loudspeakers

Never stand in the immediate vicinity of loudspeakers driven at a high level. Professional loudspeaker systems are capable of causing a sound pressure level detrimental to human health. Seemingly non-critical sound levels (from approx. 95 dB SPL) can cause hearing damage if people are exposed to it over a long period.

In order to prevent accidents when deploying loudspeakers on the ground or when flown, please take note of the following:

When setting up the loudspeakers or loudspeaker stands, make sure they are standing on a firm surface. If you place several systems on top of one another, use straps to secure them against movement.

Only use accessories which have been tested and approved by d&b for assembly and mobile deployment. Pay attention to the correct application and maximum load capacity of the accessories as detailed in our specific "Mounting instructions" or in our "Flying system and Rigging manuals".

Ensure that all additional hardware, fixings and fasteners used for installation or mobile deployment are of an appropriate size and load safety factor. Pay attention to the manufacturers' instructions and to the relevant safety guidelines.

Regularly check the loudspeaker housings and accessories for visible signs of wear and tear, and replace them when necessary.

Regularly check all load bearing bolts in the mounting devices.

CAUTION!

Loudspeakers produce a static magnetic field even if they are not connected or are not in use. Therefore make sure when erecting and transporting loudspeakers that they are nowhere near equipment and objects which may be impaired or damaged by an external magnetic field. Generally speaking, a distance of 0.5 m (1.5 ft) from magnetic data carriers (floppy disks, audio and video tapes, bank cards, etc.) is sufficient; a distance of more than 1 m (3 ft) may be necessary with computer and video monitors.

T10

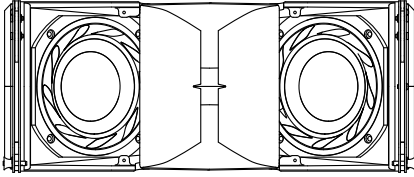

Fig. 1: T10 loudspeaker

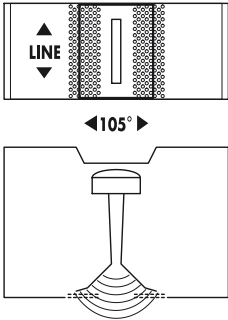

Fig. 2: T10 Horn and lens in line source setup

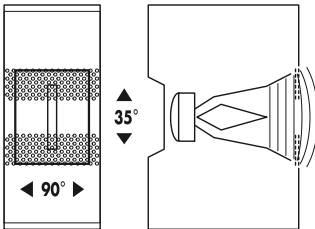

Fig. 3: T10 Horn and lens in point source setup

The T10 is a very compact loudspeaker system which can be used both as a line array and as a high directivity point source speaker. For these applications the T10 cabinet provides two different dispersion characteristics which can be swapped over without any tools.

The core of the design is a unique combination of a rotatable waveguide with horn and an acoustic lens. The horn natively provides a vertical line source with 90° horizontal dispersion. The lens is part of the front grill and widens the HF dispersion in line array mode to 105°. When used upright as a point source, the lens curves the wavefront of the line source providing a 90° x 35° dispersion pattern.

The T10 is a two way design employing dual 6.5" drivers, a 1.4" exit compression driver and a passive crossover network. The low drivers are positioned in a dipolar arrangement providing an exceptional dispersion control towards low frequencies. Its frequency response extends from 68 Hz to above 18 kHz.

The T10 enclosure is constructed from polyurethane integral hard foam with an impact and weather resistant black paint finish. The cabinet shape allows the system to be set up as a single unit in upright orientation or as a line array in user defined vertical configurations. The front of the loudspeaker cabinet is protected by a rigid metal grill in front of an acoustically transparent foam.

T-Series rigging components and arrays

For point source applications the T10 is fitted with six threaded inserts to connect to different rigging accessories like Z5371 T Flying bracket, Z5372 T Horizontal bracket, Z5354 E8/E12 Flying adapter or Z5020/25 Flying adapter 02/03.

When applied as a line array, cabinets are mechanically connected using the rigging strands on both sides of the cabinet front and a central strand at the rear of the cabinet. All necessary rigging components are mounted to the cabinet and are folded or slide out when needed. Splay angles between adjacent cabinets can be set in the range from 0° to 15°.

A detailed description of the T-Series rigging components is given in the T-Series Rigging manual which is provided with the Z5370 T Flying frame.

T10 line arrays of up to 3 cabinets can be supported with the Z5373 T Cluster bracket which allows an easy aiming of the array either flown or mounted on a high-stand.

A detailed description of planning and designing T-Series arrays is given in the technical information "TI 385 Line array design, ArrayCalc" which is also provided with the T Flying frame. The d&b ArrayCalc simulation software can be downloaded from the d&b website at www.dbaudio.com.

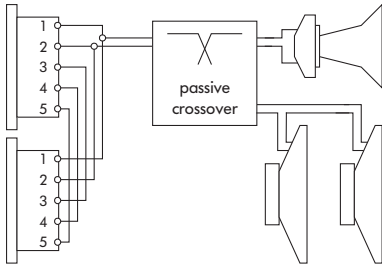

Fig. 4: Connector wiring

Connections

The T10 cabinet is fitted with a pair of EP5 connectors. All five pins of both connectors are wired in parallel. The T10 uses the pin assignments 1/2. Pins 3/4 and 5 are designated to active subwoofers, where pin 5 is used for SenseDrive (only available when using a D12 amplifier and 5-wire cabling). Using the male connector as the input, the female connector allows for direct connection to additional loudspeakers.

The T10 can be supplied with NL4 connectors as an option.

Pin equivalents of EP5 and NL4 connectors are listed in the table below.

EP5	1	2	3	4	5
NL4	1+	1-	2+	2-	n.a.

Operation

NOTICE!

Only operate d&b loudspeakers with a correctly configured d&b amplifier, otherwise there is a risk of damaging the loudspeaker components.

Applicable d&b amplifiers:

D80/D20/D12/D6/10D/30D.

Application	Setup	Cabinets per channel
T10 Line source	T10 Arc / T10 Line	4
T10 Point source	T10 PS	4

For applicable d&b amplifiers the setups are available in Dual Channel or Mix TOP/SUB mode.

"T10 Arc" and "T10 Line" setups

These setups are selected when T10 loudspeakers are used as line sources. The selection depends on the curvature of the array. Both setups may be used within one array.

The "Arc" setup is used for T10 loudspeakers when used in curved array sections.

The "Line" setup is used for long throw array sections with three or more consecutive splay settings of 0°, 1° or 2°. Compared to the "Arc" setup, the upper mid range is reduced to compensate for the extended near field.

The transition from "Line" to "Arc" configuration within the array is made according to the splay progression but may allow for certain deviations due to the wiring of the cabinets in groups of up to four.

"T10 PS" setup

This setup has to be selected when T10 loudspeakers are configured as a point source or when used as single cabinets with horn in line array configuration (e.g. front fill or ceiling mounted).

Controller settings

For acoustic adjustment the functions CUT, HFA, HFC and CPL can be selected.

CUT circuit

Set to CUT, the T10 low frequency level is reduced. The T10 is now configured for use with the T-SUB or other d&b active subwoofers.

HFA circuit (T10 PS setup only)

In HFA mode (High Frequency Attenuation), the HF response of the T10 system is rolled off. HFA provides a natural, balanced frequency response when a unit is placed close to listeners in near field or delay use.

High Frequency Attenuation begins gradually at 1 kHz, dropping by approximately 3 dB at 10 kHz. This roll-off mimics the decline in frequency response experienced when listening to a system from a distance in a typically reverberant room or auditorium.

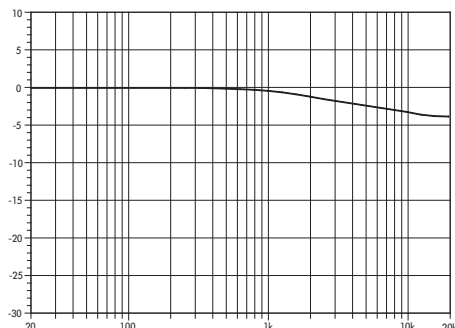

Fig. 5: Frequency response correction of HFA circuit

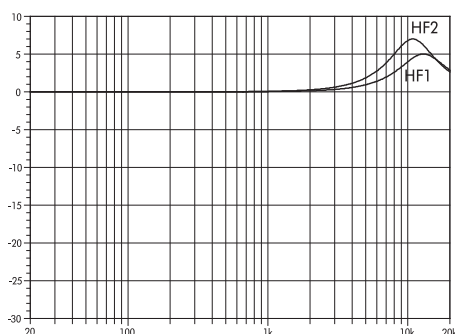

Fig. 6: Frequency response correction of HFC circuit

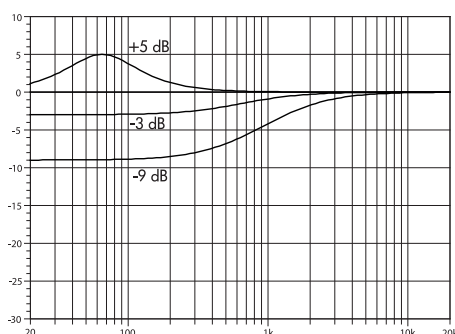

Fig. 7: Frequency response correction of CPL circuit

HFC circuit (T10 Arc/Line setups only)

Selecting the HFC (High Frequency Compensation) circuit compensates for loss of high frequency energy due to absorption in air when loudspeakers are used to cover far field listening positions.

The HFC circuit has two settings (HF1, HF2) for different distance ranges the cabinets have to cover. The settings should be used selectively, only for those cabinets covering the respective distances, HF1 for distances larger than 25 m (80 ft) and HF2 for distances larger than 50 m (160 ft).

The compensation is adjusted for a typical relative humidity of 40 %. With lower humidity the absorption by air increases therefore the distances where the respective HFC setting provides a correct equalization are shorter than indicated above.

Using the HFC function provides the correct sound balance between close and remote audience areas, whilst all amplifiers driving the array can be fed with the same signal.

CPL circuit

The CPL (Coupling) circuit compensates for coupling effects between the cabinets; these effects increase as the length of the line array is extended. CPL begins gradually at 1 kHz, with the maximum attenuation below 400 Hz, providing a balanced frequency response when T10 cabinets are used in arrays of four or more. The function of the CPL circuit is shown in the diagram opposite and can be set in dB attenuation values between -9 and 0, or a positive CPL value which creates an adjustable low frequency boost around 65 Hz (0 to +5 dB).

Note: Make sure that all cabinets within the line array are operated with the same CPL setting.

Dispersion characteristics

The graphs below show dispersion angle over frequency of a single T10 cabinet plotted using lines of equal sound pressure (isobars) at -6 dB and -12 dB.

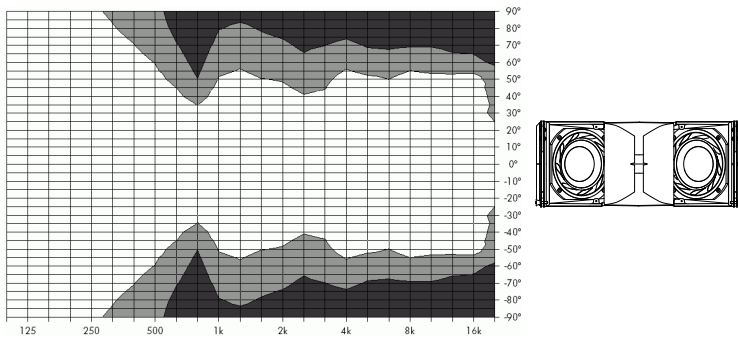

Fig. 8: Isobar diagram T10 line source, horizontal

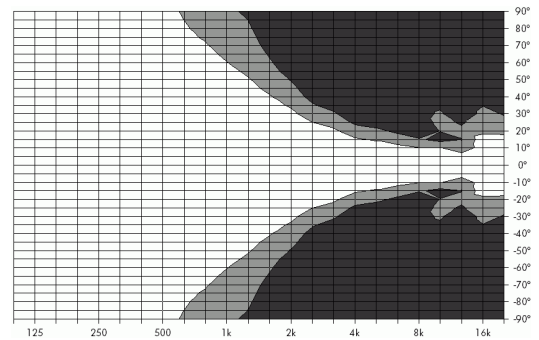

Fig. 9: Isobar diagram T10 line source, vertical

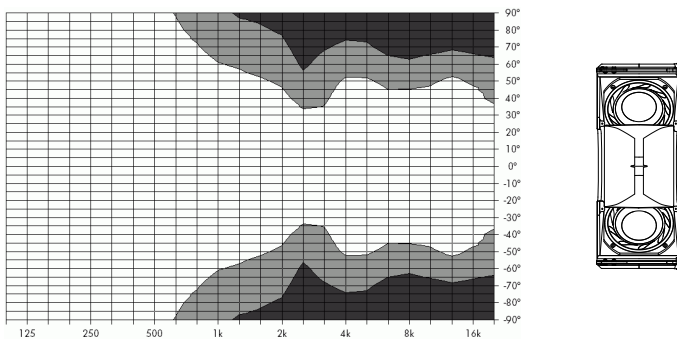

Fig. 10: Isobar diagram T10 point source, horizontal

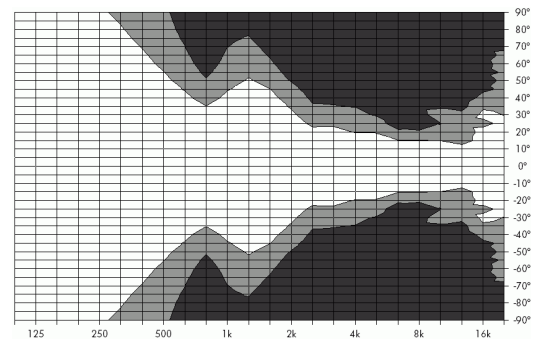

Fig. 11: Isobar diagram T10 point source, vertical

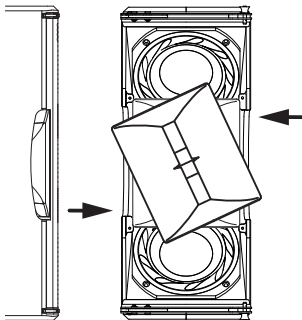

Fig. 12: Rotating the horn
(shown without front grill for better illustration)

Altering the HF dispersion

Swapping between point and line source setups is performed by simply rotating the horn by 90°. The horn is easily accessible from outside of the cabinet and can be rotated without any tools or removal of the front grill.

This is achieved through apertures on the cabinet sides by a mechanism that provides detents at both the line and point source positions.

Technical specifications

T10 system data

Frequency response (-5 dB standard).....	68 Hz ... 18 kHz
Frequency response (-5 dB CUT mode).....	120 Hz ... 18 kHz
Max. sound pressure (Line/Arc setups, 1 m, free field).....	
with D6/10D.....	129 dB
with D80/D20/D12/30D.....	132 dB
Max. sound pressure (PS setup, 1 m, free field).....	
with D6/10D.....	127 dB
with D80/D20/D12/30D.....	130 dB
	(SPLmax peak, pink noise test signal with crest factor of 4)
Input level (100 dB-SPL/1 m).....	-13 dBu

T10 loudspeaker

Nominal impedance.....	16 ohms
Power handling capacity (RMS / peak 10 ms).....	200/800 W
Nominal dispersion angle (point source, hor. x vert.).....	90° x 35°
Nominal dispersion angle (line array, horizontal).....	105°
Splay angle settings.....	0...15° (1° increment)
Components.....	2 x 6.5" driver with neodymium magnet
.....	1.4" exit compression driver on rotatable waveguide
.....	Passive crossover network
Connections.....	2 x EP5
.....	Optional: 2 x NL4
Pin assignments.....	EP5: 1/2
.....	NL4: 1+/1-
Weight.....	11 kg (24 lb)

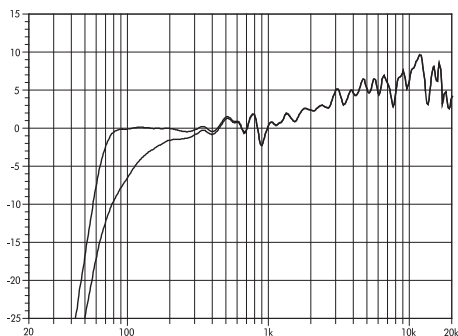

Fig. 13: T10 frequency response line source, single cabinet, standard and CUT settings

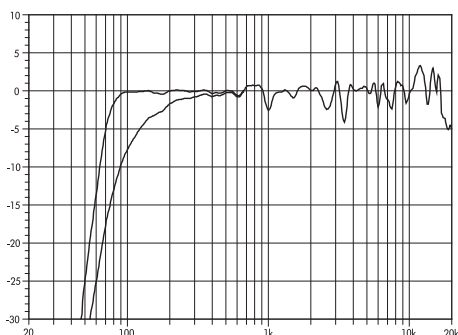

Fig. 14: T10 frequency response point source, standard and CUT settings

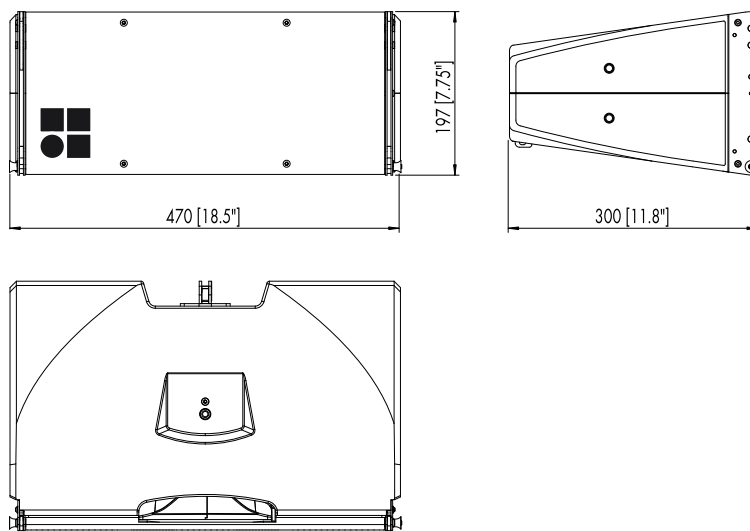

Fig. 15: T10 cabinet dimensions in mm [inch]

Manufacturer's Declarations



EU conformity of loudspeakers (CE symbol)

This declaration applies to

T10 loudspeaker, Z0550

manufactured by d&b audiotechnik GmbH.

All production versions of these types are included, provided they correspond to the original technical version and have not been subject to any later design or electromechanical modifications.

We herewith declare that said products are in conformity with the provisions of the respective EC directives including all applicable amendments.

A detailed declaration is available on request and can be ordered from d&b or downloaded from the d&b website at www.dbaudio.com.

WEEE Declaration (Disposal)

Electrical and electronic equipment must be disposed of separately from normal waste at the end of its operational lifetime.

Please dispose of this product according to the respective national regulations or contractual agreements. If there are any further questions concerning the disposal of this product please contact d&b audiotechnik.

